

KENGO KUMA

# INCASTRI

GI  
GESSI



INCAS TRI

chapter	1	THE DIALOGUE BETWEEN VISION AND MEMORY <small>IL DIALOGO TRA VISIONE E MEMORIA</small>	13
chapter	2	MATTER, LIGHT, EMOTION <small>MATERIA, LUCE, EMOZIONE</small>	27
chapter	3	THE GRAMMAR OF SPACE <small>LA GRAMMATICA DELLO SPAZIO</small>	47

# I N D E X

chapter	4	A STORY TO BE TOLD <small>UNA STORIA DA RACCONTARE</small>	61
chapter	5	THE ARTISTIC VALUE OF DESIGN <small>IL VALORE ARTISTICO DEL DESIGN</small>	75
chapter	6	PRODUCT LIST	93

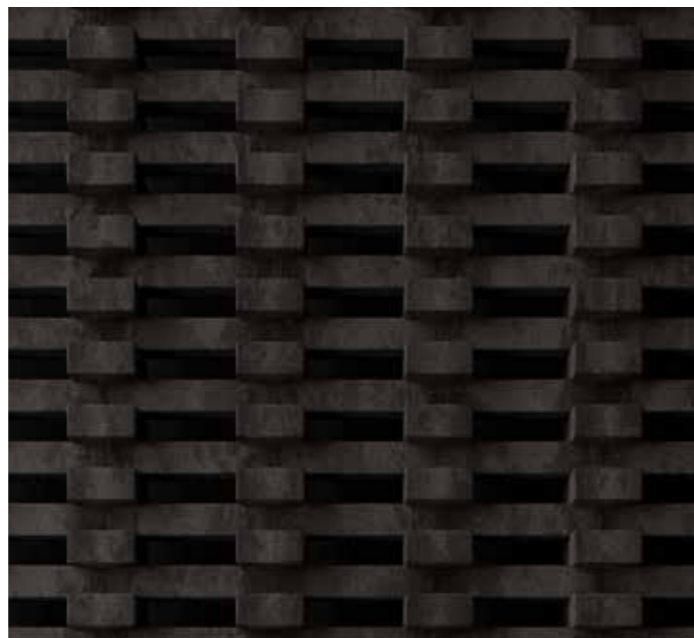

EQUILIBRIO E MINIMALISMO  
BALANCE  
AND  
MINIMALISM

Incastri is a measured expression of balance, where essence becomes form and emptiness gains value. Sober lines, light geometries and calibrated compositions give life to a minimal, silent and profound design language. A language inspired by the design philosophy of Kengo Kuma, where subtraction reveals, and where every element engages with space in a respectful and harmonious way. The result is a collection that celebrates lightness, proportion and the sense of matter with natural elegance.

Incastri è un'espressione misurata di equilibrio, dove l'essenzialità diventa forma e il vuoto acquista valore. Linee sobrie, geometrie leggere e composizioni calibrate danno vita a un'estetica minimale, silenziosa e profonda. Un linguaggio che si ispira alla filosofia progettuale di Kengo Kuma, dove sottrarre significa rivelare, e dove ogni elemento dialoga con lo spazio in modo rispettoso e armonico. Il risultato è una collezione che celebra la leggerezza, la proporzione e il senso della materia con eleganza naturale.



Incastri è il risultato di un incontro armonioso tra la maestria artigianale giapponese e la visione progettuale di Gessi. Le tecniche tradizionali come Chidori, l'incastro strutturale senza chiodi, Yakisugi, tecnica millenaria di carbonizzazione del legno, e Chōzu, il rituale della purificazione attraverso l'acqua, vengono reinterpretate con rispetto e sensibilità, per dar vita a una collezione che custodisce la memoria del gesto e la purezza della materia. Ogni elemento si incastra con precisione, creando un ritmo visivo fatto di pieni e vuoti, luce e ombra, che richiama la poetica del costruire tipica della cultura nipponica. Il design, ispirato alla filosofia di Kengo Kuma, diventa così un'espressione autentica di equilibrio e minimalismo.

## TRADIZIONE E ARTIGIANALITÀ TRADITION AND CRAFTSMANSHIP

Incastri is the result of a harmonious encounter between Japanese craftsmanship and Gessi's design vision. Traditional techniques such as Chidori - a structural joint without nails, Yakisugi - an ancient method of wood charring, and Chōzu - the ritual of purification through water, are reinterpreted with respect and sensitivity, giving life to a collection that preserves the memory of gesture and the purity of matter. Each element fits precisely, creating a visual rhythm of solids and voids, light and shadow, evoking the poetics of construction typical of Japanese culture. The design, inspired by Kengo Kuma's philosophy, becomes an authentic expression of balance and minimalism.

**KENGO KUMA**

Photo (C) J.c. Carbonne

**INCASTRI**

## **KENGO KUMA**

Kengo Kuma is one of the most prominent contemporary architects renowned worldwide. His hallmark style interlocks wooden elements with recurring motifs that become design elements, a tribute to Japanese tradition. Our shared vision is rooted in the celebration of artisanal craftsmanship, characterized by unique gestures and techniques, ultimately transforming them into iconic design masterpieces.

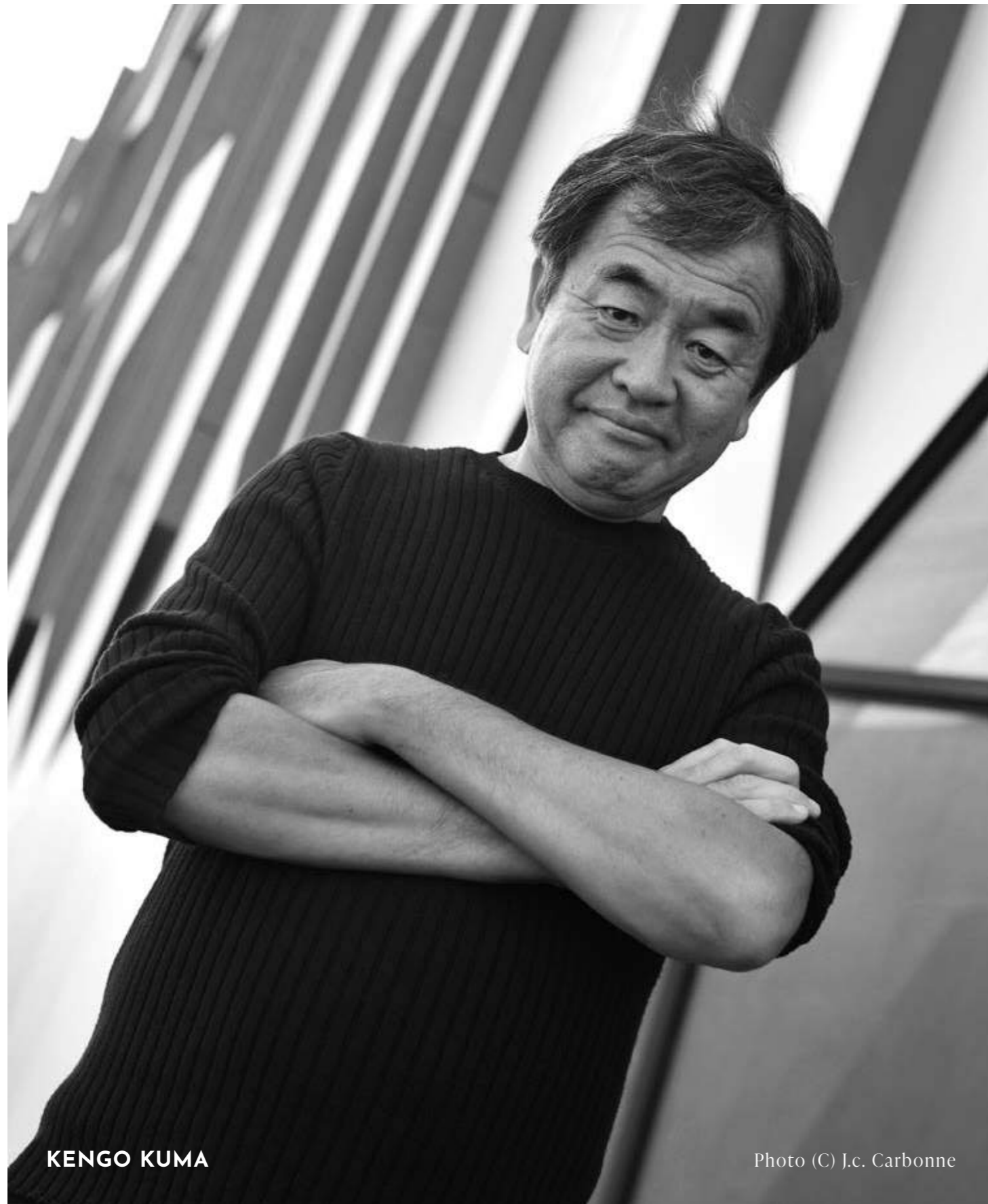
Kengo Kuma è uno dei più importanti architetti contemporanei dalla fama internazionale. La sua firma stilistica è caratterizzata dall'utilizzo di incastri di materiali lignei e segni che si ripetono tra loro diventando elementi di design, in stretta relazione con elementi della tradizione giapponese. La visione che ci accomuna è legata all'esaltazione dell'approccio artigianale, fatto di gesti e lavorazioni uniche. Fino a trasformarle in opere dal design iconico.

**GESSI**



chapter

## THE DIALOGUE BETWEEN VISION AND MEMORY

### IL DIALOGO TRA VISIONE E MEMORIA

The reference to natural materials, traditional techniques and essential language transforms the design of Incastri into a sensory experience that celebrates the harmony between man and environment.

Il riferimento ai materiali naturali, alle tecniche artigianali e al linguaggio essenziale trasformano il design di Incastri in un'esperienza sensoriale che esalta l'armonia tra uomo e ambiente.





TEXTURE E TATTILITÀ  
T E X T U R E  
A N D  
T A C T I L I T Y

Incastri is enriched by a play of light and shadow, thanks to a seamless texture in which staggered elements create interlocking effect.

Incastri si arricchisce di un gioco luce-ombra grazie ad una texture senza soluzione di continuità, in cui elementi sfalsati creano appunto giochi di incastri.



**75002#706** Basin mixer without waste  
Miscelatore lavabo senza scarico

INCASTRI

LA BELLEZZA DI  
UN'IDENTITÀ SILENZIOSA

THE BEAUTY  
OF A SILENT  
IDENTITY



In Japanese thought, Chidori represents the philosophy of binding without forcing: it is the art of allowing elements to coexist in balance, with respect for the material and its function. It is a form of silent design, where beauty arises from the structure itself.

Nel pensiero giapponese, il Chidori rappresenta la filosofia del legare senza forzare: è l'arte di far convivere gli elementi in equilibrio, con rispetto per il materiale e per la funzione. È una forma di design silenzioso, in cui la bellezza nasce dalla struttura stessa.



INCASTRI

INCASTRI



75004#707 High version basin mixer  
without waste / Miscelatore  
lavabo alto senza scarico

75002#706 Basin mixer without waste /  
Miscelatore lavabo senza  
scarico

GESSI



INCASTRATI



GESSI



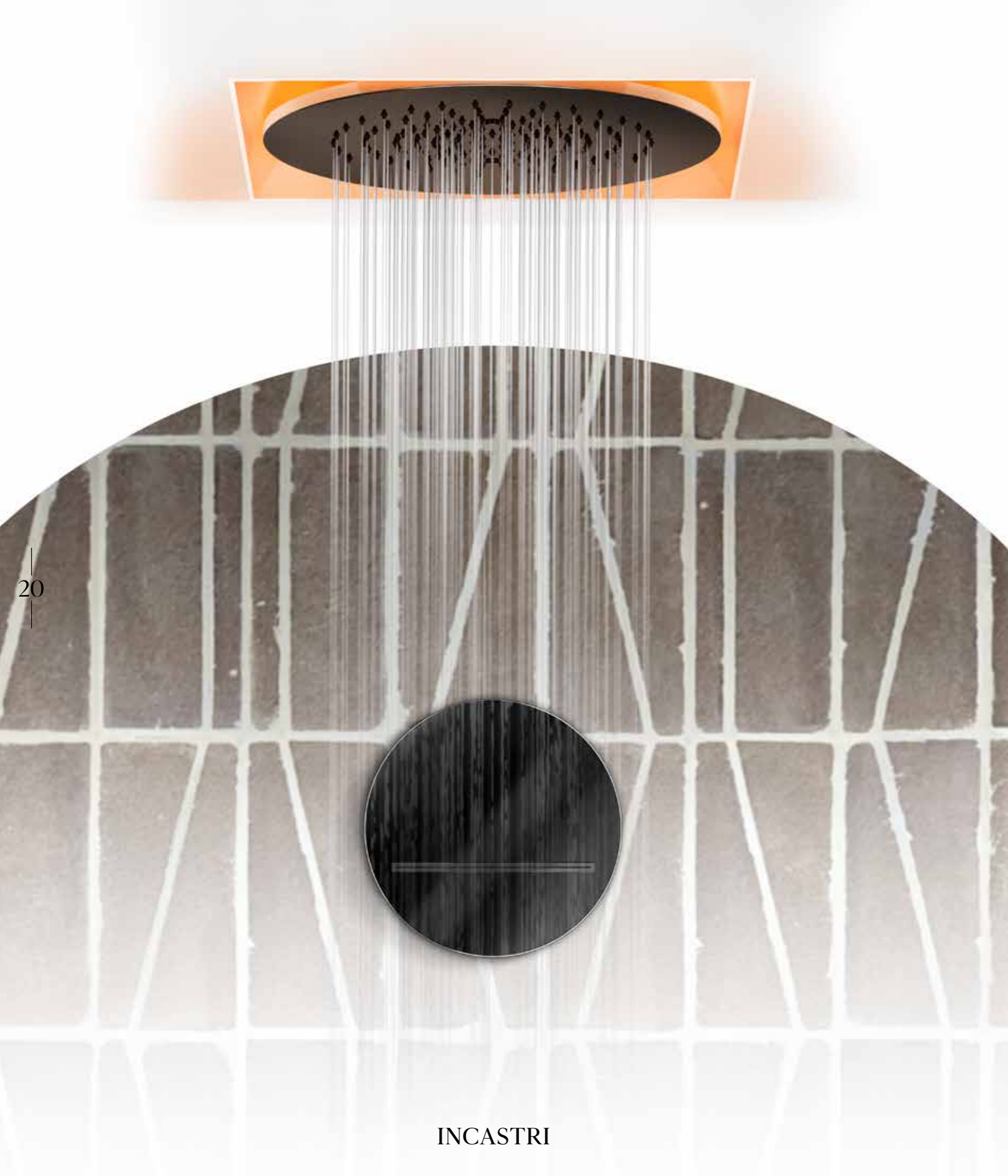

20

INCASTRI

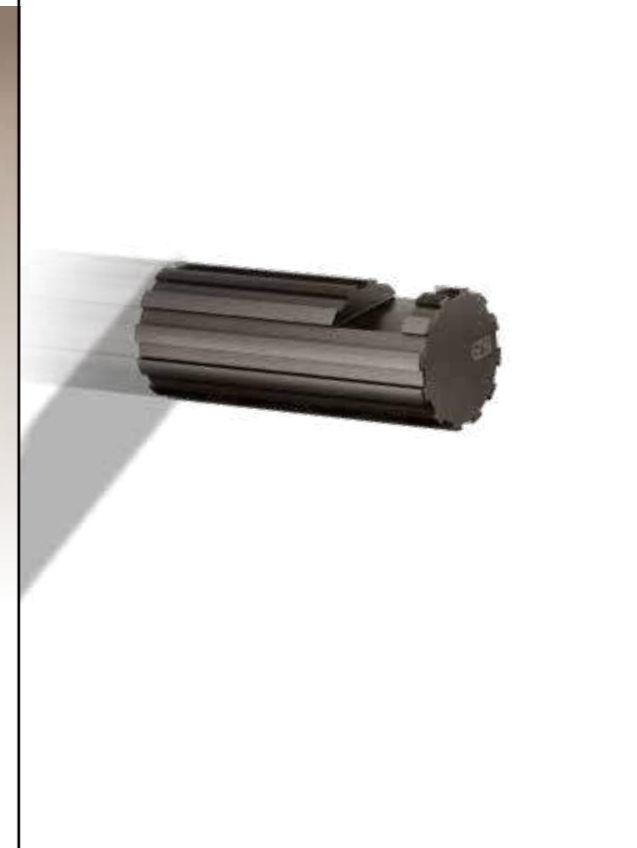

Controls and accessories are enriched by a distinctive texture, offering visual depth and tactile appeal, emphasising the contrast between smooth and engraved surfaces, making each element not only functional but also expressive.

## SCULPTED FROM MATTER

### SCOLPITO NELLA MATERIA

Comandi e accessori si arricchiscono di una texture distintiva, che dona profondità visiva e tattilità, enfatizzando il contrasto tra superfici lisce e incise rendendo ogni elemento non solo funzionale ma anche espressivo.

**09268\_75338** Thermostatic mixer with 4 separate exits /  
Miscelatore termostatico a 4 uscite  
indipendenti

**75521** Wall-mounted robe hook /  
Appendino a parete

**75632** Glass Door double handle 45 cm /  
Maniglia per vetro doppia 45 cm



21

GESSI

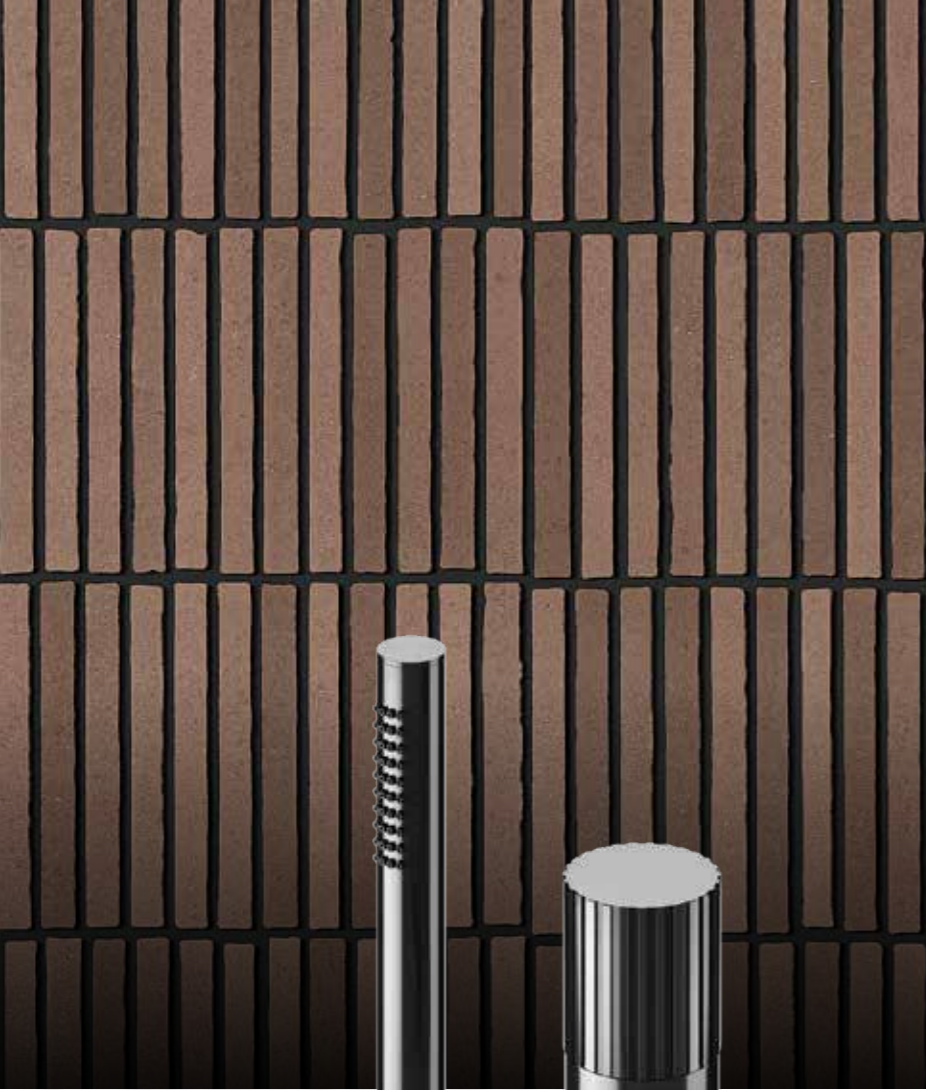

PERFECT  
ARCHITECTURAL  
INTEGRATION

PERFETTA INTEGRAZIONE  
ARCHITETTONICA

46189\_75028 Freestanding bath mixer /  
Miscelatore vasca da terra



GESSI



INCASTRI

chapter

## 2

MATTER,  
LIGHT, EMOTION

## MATERIA, LUCE, EMOZIONE

The design blends architectural elements with an aesthetic that is essential yet refined, giving life to forms in which the balance of gleam and reflection transforms everyday gestures into rituals of emotion and beauty.

Il design fonde elementi architettonici a un'estetica essenziale ma ricercata, dando vita a forme in cui l'equilibrio tra bagliori e riflessi, trasforma il gesto quotidiano in rituali di emozioni e bellezza.

GESSI



INCASTRI

GESSI



Clean geometries, compact volumes and slender diameters enhance the elegance of the structure. Refined workmanship accentuates reliefs, creating a sophisticated visual balance. The suspended mixer embodies the pinnacle of this formal exploration: an innovation where minimal proportions evoke lightness and elevate the silhouette.

Geometrie pulite, volumi contenuti e diametri sottili esaltano l'eleganza della struttura. Le lavorazioni raffinate accentuano i rilievi, creando un sofisticato equilibrio visivo. Il miscelatore sospeso incarna il culmine di questa ricerca formale: un'innovazione in cui proporzioni minimali evocano leggerezza ed esaltazione della figura.

**AESTHETIC PRECISION**  
REFINED  
SIMPLICITY

75251#726 Basin mixer with stop&go waste /  
Miscelatore con scarico stop&go

INCASTRI



GESSI

**RIGORE ESTETICO**

REFINED SIMPLICITY

AESTHETIC

PRECISION

Design leads technology: the suspended mixer boasts a functional, articulated structure essential for preserving the purity of its aesthetic lines.

Il design guida la tecnologia: il miscelatore sospeso vanta una struttura funzionale articolata ma fondamentale per preservare la pulizia delle linee estetiche.



75202#726 Basin mixer without waste. Sospeso / Miscelatore lavabo senza scarico. Sospeso

75204#735 High version basin mixer without waste. Sospeso/ Miscelatore lavabo senza scarico. Sospeso



75437 Standing soap dispenser, ghiaccio / Dispenser da appoggio, ghiaccio



# INCASTRI

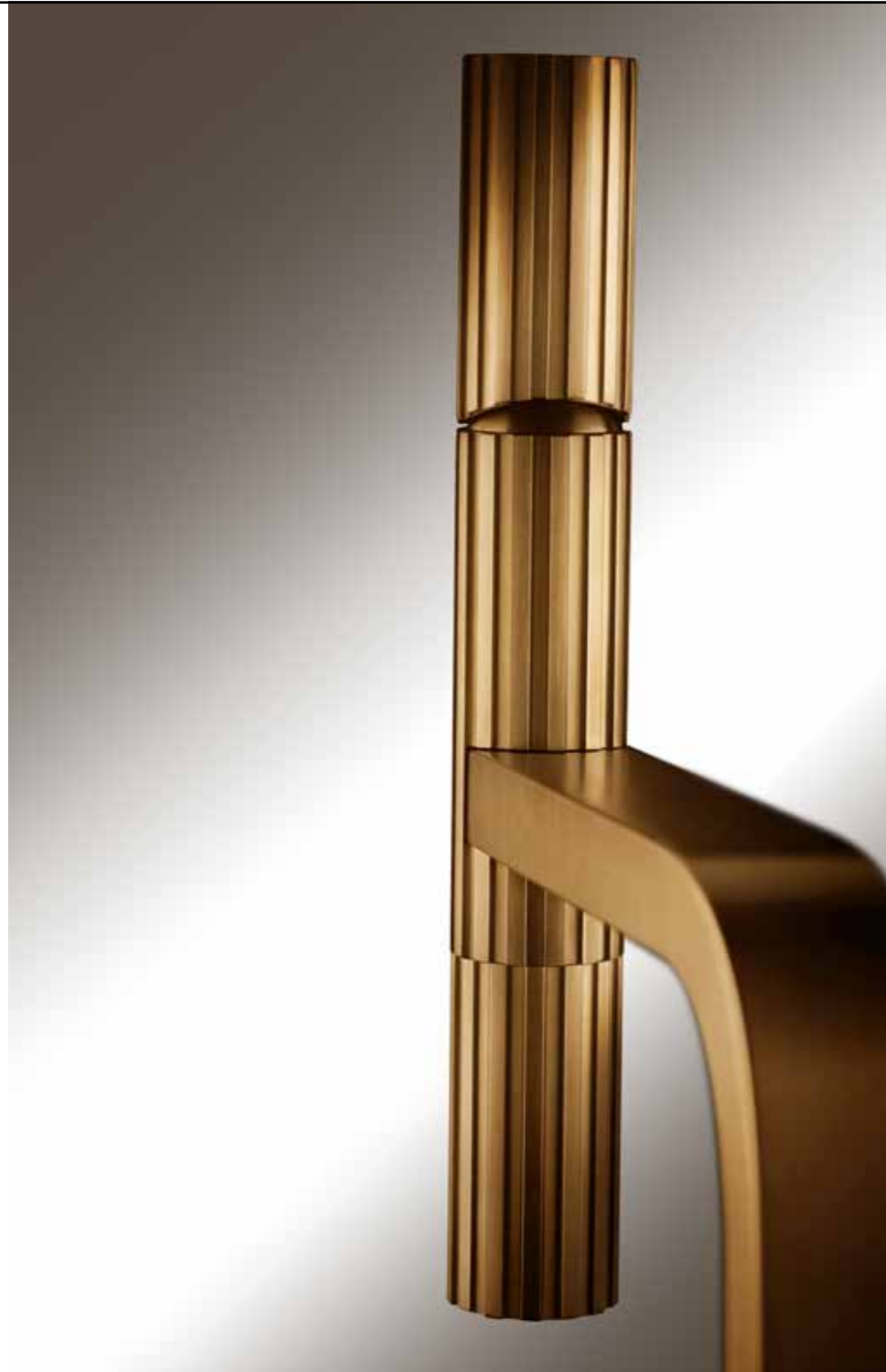

75204#726 High version basin mixer without waste. Sospeso/  
Miscelatore lavabo senza scarico. Sospeso

75603#561 Counter washbasin 65x40 cm /  
Lavabo da appoggio 65x40 cm

INCASTRI



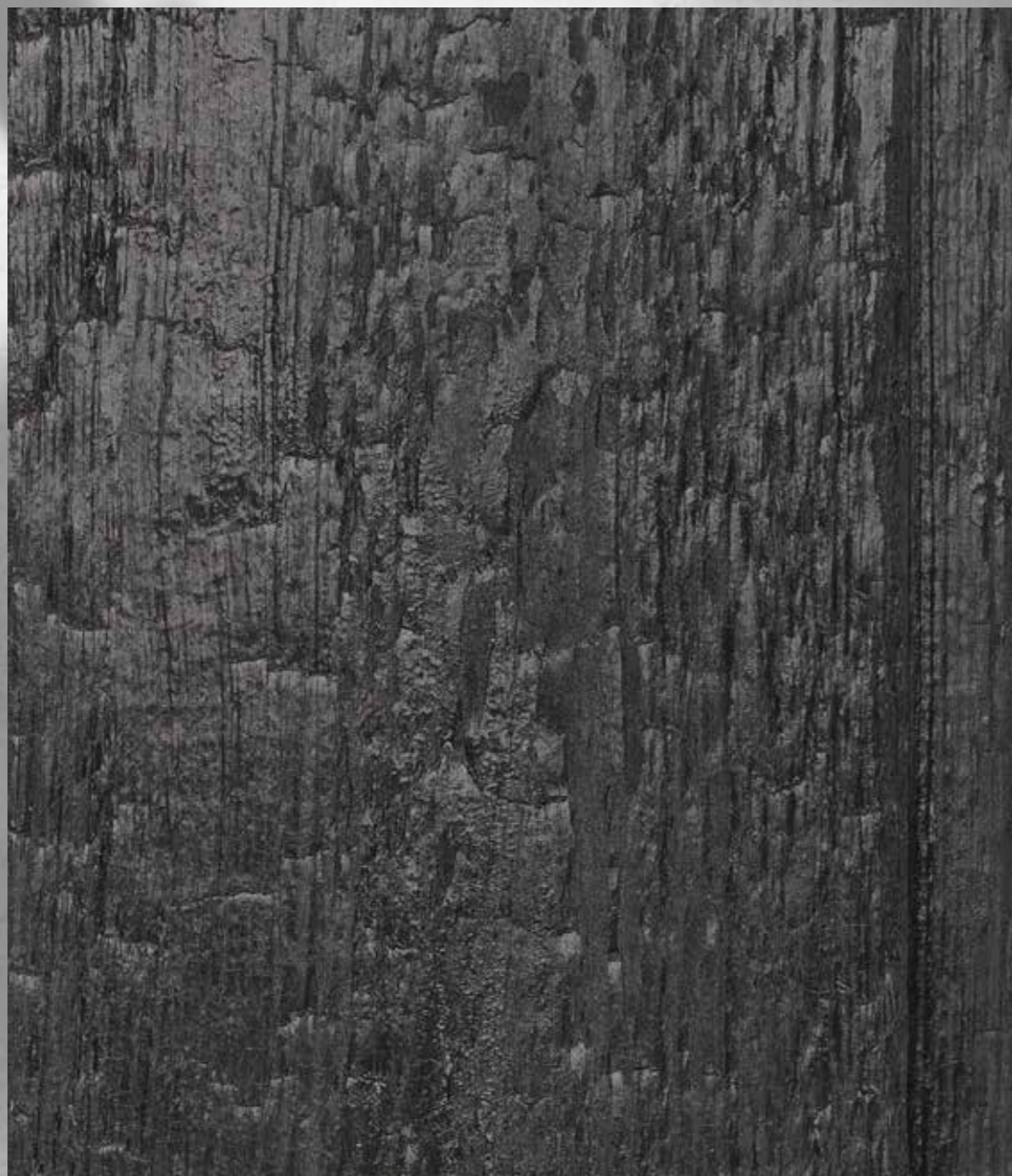

## JAPANESE TRADITION

## CULTURA GIAPPONESE

The collection's basins reinterpret the ancient Japanese technique of Yakisugi - a method of charring wood to make it water-resistant - translating its essence into a new material.

I lavabi della collezione reinterpretano l'antica tecnica giapponese Yakisugi, un metodo di carbonizzazione del legno impiegato per renderlo impermeabile, traducendone l'essenza in una nuova materia.



INCASTRI

GESSI

# INCASTRI

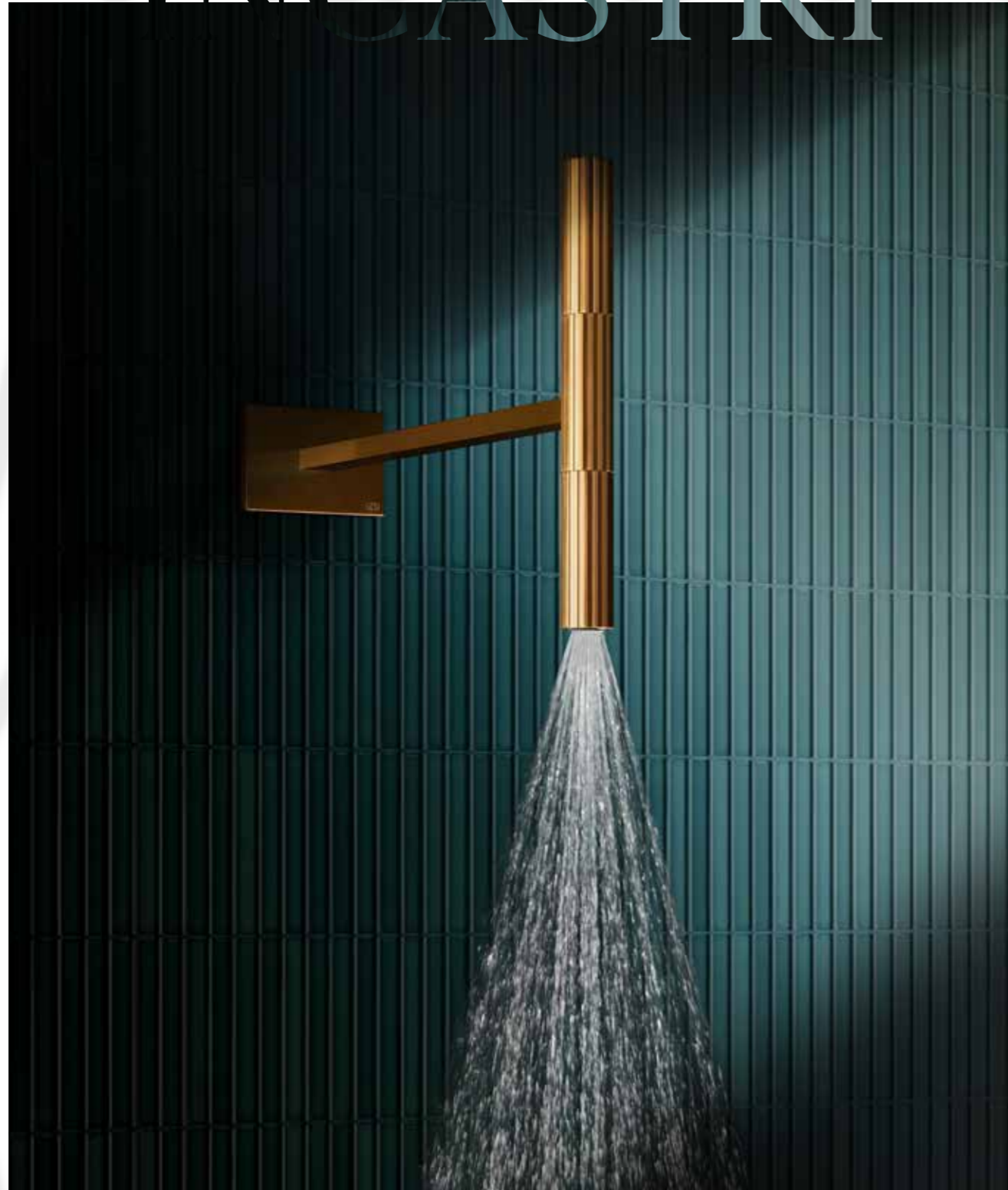

75148#726 Wall-mounted shower head /  
Soffione a parete

INCASTRI



75497#735 Wall-mounted towel holder 30 cm /  
Porta salviette a parete 30 cm

54139\_75036#735 Wall-mounted two-ways shower mixer with  
handshower / Miscelatore doccia a parete,  
due vie con doccia

Le tecniche tradizionali giapponesi trovano espressione su tutti gli elementi della collezione Incastri, come ad esempio gli accessori porta salviette. dove equilibrio, precisione e armonia con la materia celebrano la tecnica Chidori.

## EQUILIBRIO ED ESSENZIALITÀ BALANCE AND ESSENCE

Traditional Japanese techniques find expression across every element of the Incastri collection, such as the towel holders, where balance, precision and harmony with matter celebrate the Chidori technique.



GESSI



75611#845 Cover plate /  
Placca di finitura



75068#726 Bidet mixer without waste /  
Miscelatore bidet senza scarico



75421#735 Wall-mounted brush holder /  
Porta scopino a parete

Incastri is enriched by all the elements constituting a total look - from accessories to flush plates - reproducing the collection's distinctive characteristics.

## SOFISTICATO MINIMALISMO S O P H I S T I C A T E D M I N I M A L I S M

Incastri si arricchisce di tutti gli elementi del total look, dagli accessori alle placche wc, replicando le caratteristiche distintive della collezione.

INCASTRI



GESSI

Le maniglie si caratterizzano per l'alternanza di rilievi, chiaroscuro e texture che conferiscono profondità visiva e ricchezza tattile, in un dialogo continuo con l'ambiente.

## LA CURA DEI DETTAGLI ATTENTION TO DETAIL

The handles are defined by an interplay of reliefs, light and shadow, and texture, providing visual depth and tactile richness, in a continuous dialogue with the surrounding space.



75542#735 Door handles set /  
Set due maniglie per porta

75543#735 Door lock /  
Chiavistello

INCASTRI





chapter 3

THE GRAMMAR  
OF SPACE

LA GRAMMATICA DELLO SPAZIO

Incastri interprets space as both structure and relationship. Each component is conceived to integrate, support and converse - a formal grammar where detail becomes architecture.

Incastri interpreta lo spazio come struttura e relazione. Ogni componente nasce per integrarsi, sostenere, dialogare: una grammatica formale in cui il dettaglio diventa architettura.



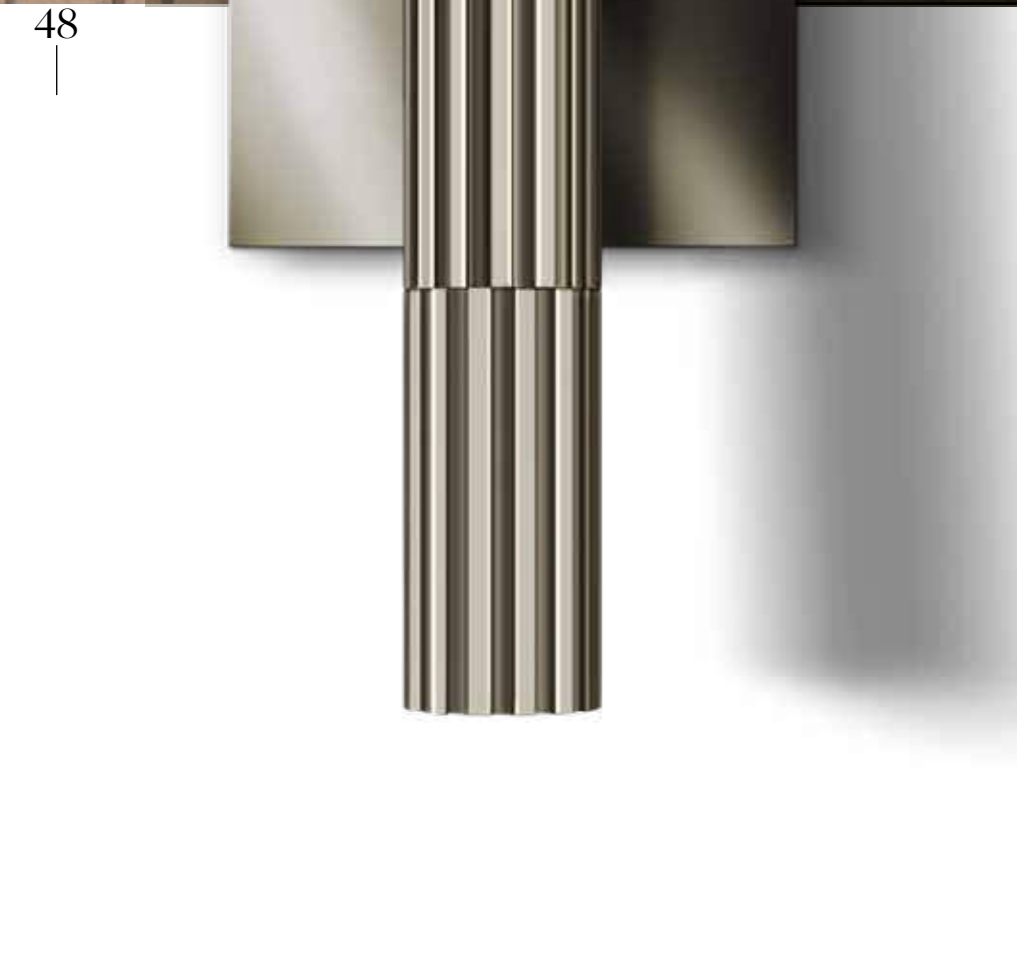

09280\_75288#720 Wall-mounted basin mixer. Sospeso /  
Miscelatore lavabo a parete. Sospeso

The body and control levers are enhanced by a distinctive vertical texture, bringing visual depth and tactility while highlighting the contrast between smooth and engraved surfaces. This detail creates a refined chiaroscuro, making every element not only functional but also expressive.

### TRAME LUMINOSE LUMINOUS WEAVES

Il corpo e le leve di apertura si arricchiscono di una texture verticale distintiva, che dona profondità visiva e tattilità, enfatizzando il contrasto tra superfici lisce e incise. Questo dettaglio dà vita a un raffinato chiaroscuro, rendendo ogni elemento non solo funzionale ma anche espressivo.

INCASTRI

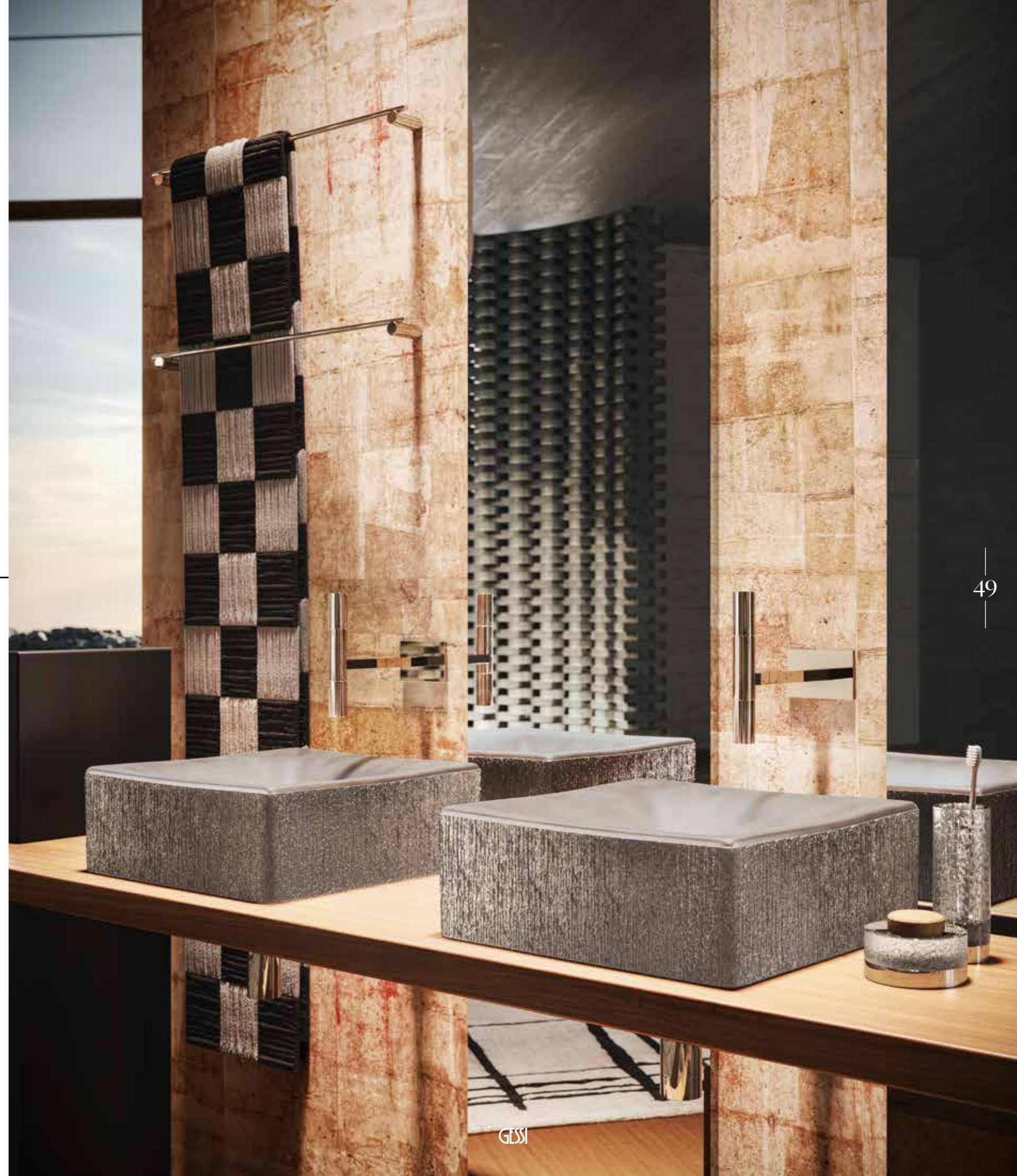

GESSI

IL RITORNO  
DELLE ORIGINI

A RETURN  
TO THE ORIGINS

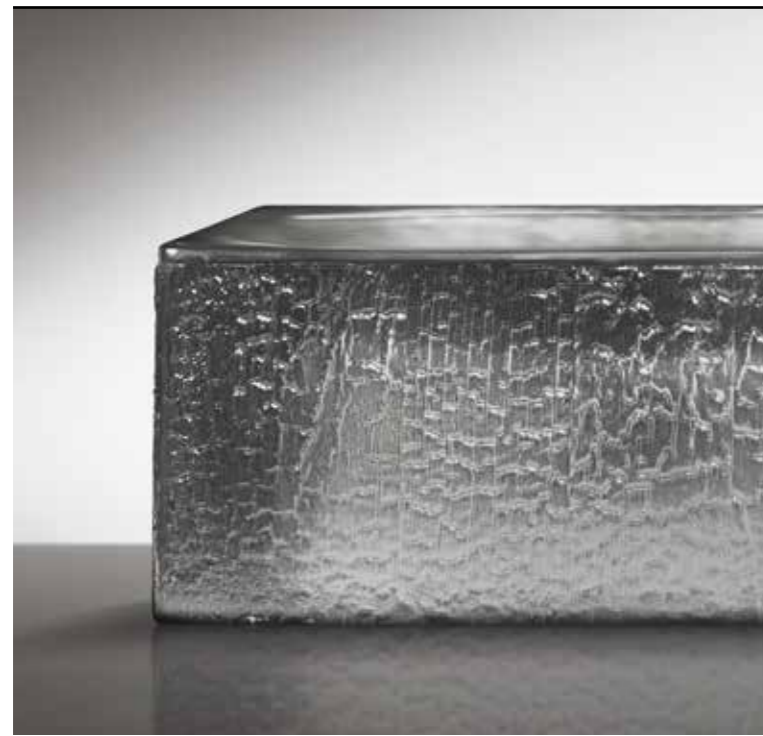

75601 Counter washbasin 40x40 cm /  
Lavabo da appoggio 40x40 cm

75431#149 Standing tumbler holder /  
Porta bicchiere da appoggio

75425#149 Standing soap holder /  
Porta sapone da appoggio



Durable and versatile, the next-generation resin allows for complex processing and refined geometries, giving rise to surfaces with a unique material quality and a three-dimensional texture reminiscent of charred wood.

Resistente e versatile, la resina di nuova generazione consente lavorazioni complesse e geometrie ricercate, dando vita a superfici dalla matericità unica e una texture tridimensionale che richiama l'effetto del legno bruciato.

# INCASTRI



52

INCASTRI



53

**09280\_75288#720** Wall-mounted basin mixer. Sospeso /  
Miscelatore lavabo a parete. Sospeso

**75601** Counter washbasin 40x40 cm /  
Lavabo da appoggio 40x40 cm

**UNA PRESENZA NATURALE  
NELLO SPAZIO**

A N A T U R A L  
P R E S E N C E  
W I T H I N T H E S P A C E

GESI

THE HARMONY  
OF INTERLOCKING  
FORMS

L'ARMONIA DEGLI  
INCASTRI



**54139\_75036#720** Wall-mounted two-ways shower mixer with handshower /  
Miscelatore doccia a parete, due vie con doccia

**75103#720** Wall-mounted bath spout /  
Bocca vasca a parete

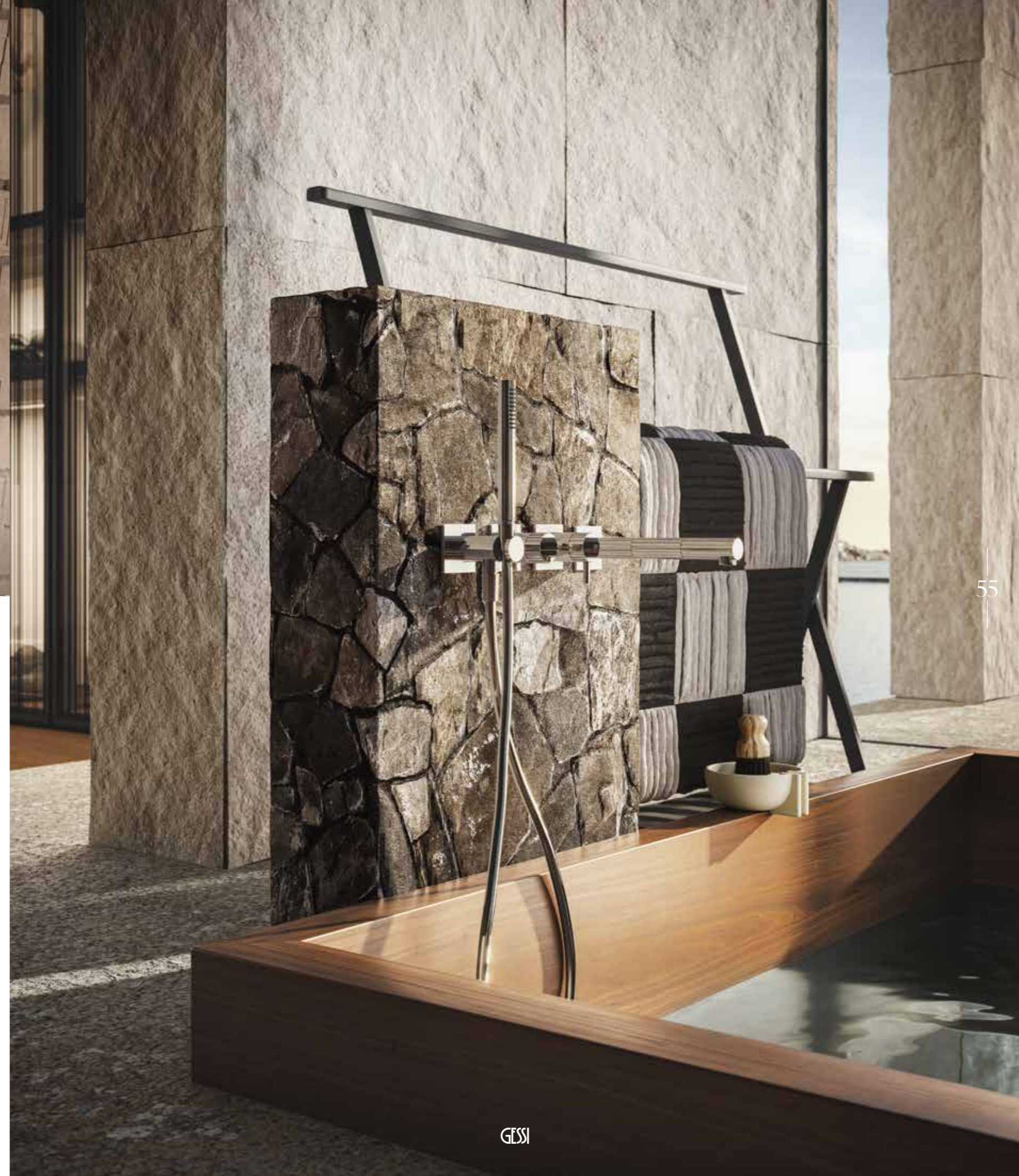

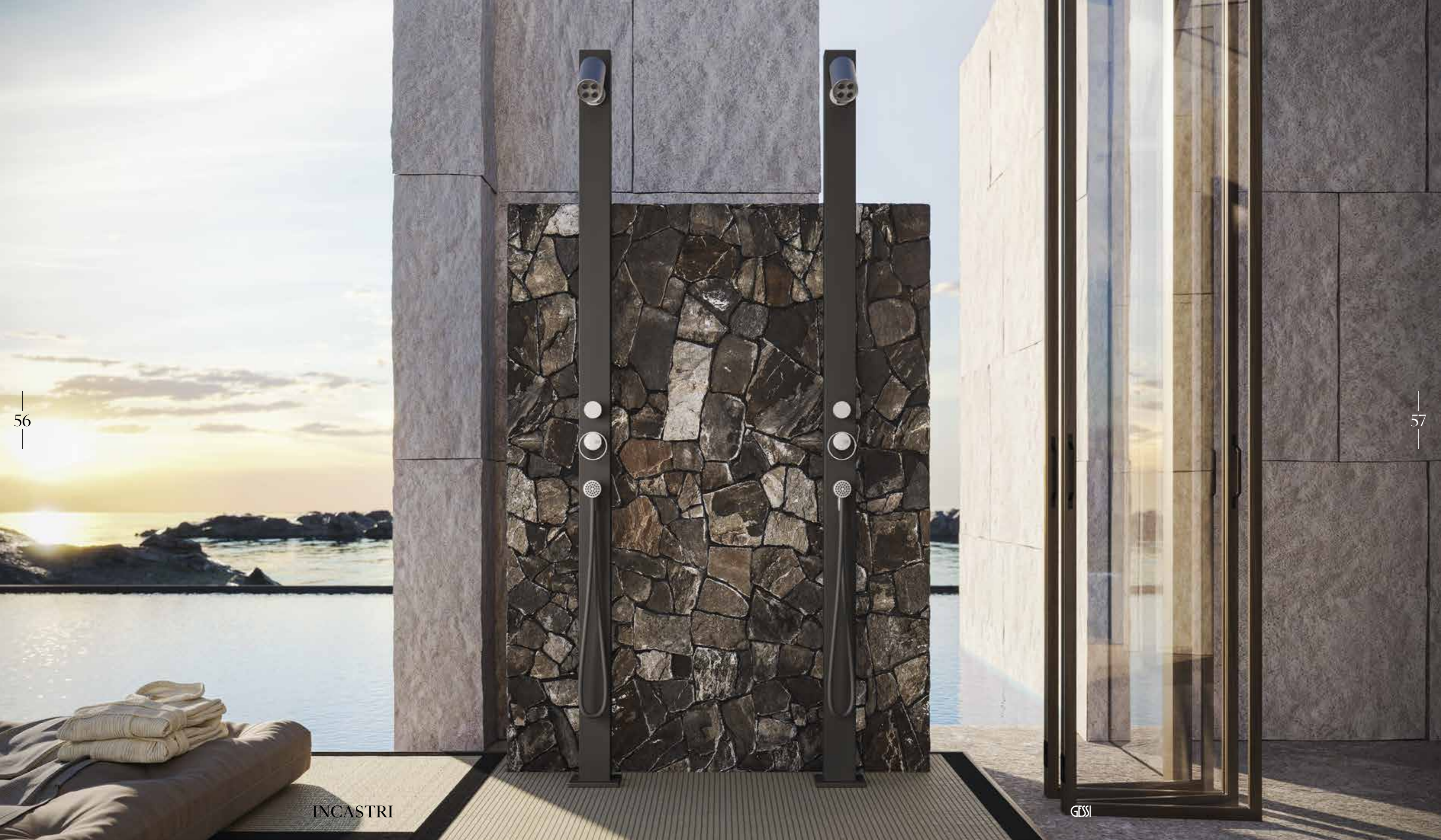



#030

#708

# 4

chapter

## A STORY TO BE TOLD

### UNA STORIA DA RACCONTARE

Incastri invites exploration through the senses, enveloping the user in an atmosphere of tactile surfaces, slender geometries and details that capture the light. It is an architecture that evokes emotion, capable of leaving its mark in the silence that surrounds us.

Incastri si esplora con i sensi, avvolgendo la persona in un'atmosfera fatta di superfici tattili, geometrie sottili e dettagli che catturano la luce. È un'architettura che emoziona, capace di lasciare traccia nel silenzio che ci circonda.



## LINGUAGGIO POETICO E SENSORIALE

## A POETIC AND SENSORY LANGUAGE

Lightness is a recurring theme - not only physical, but visual and emotional: The three-hole version enters into dialogue with its surroundings through a poetic and sensory language.

La leggerezza è un tema costante, non solo fisica ma anche visiva ed emotiva: la versione tre fori dialoga con il contesto attraverso un linguaggio poetico e sensoriale.

75014#030 Three-hole basin mixer without waste /  
Miscelatore lavabo tre fori senza scarico



INCASTRI

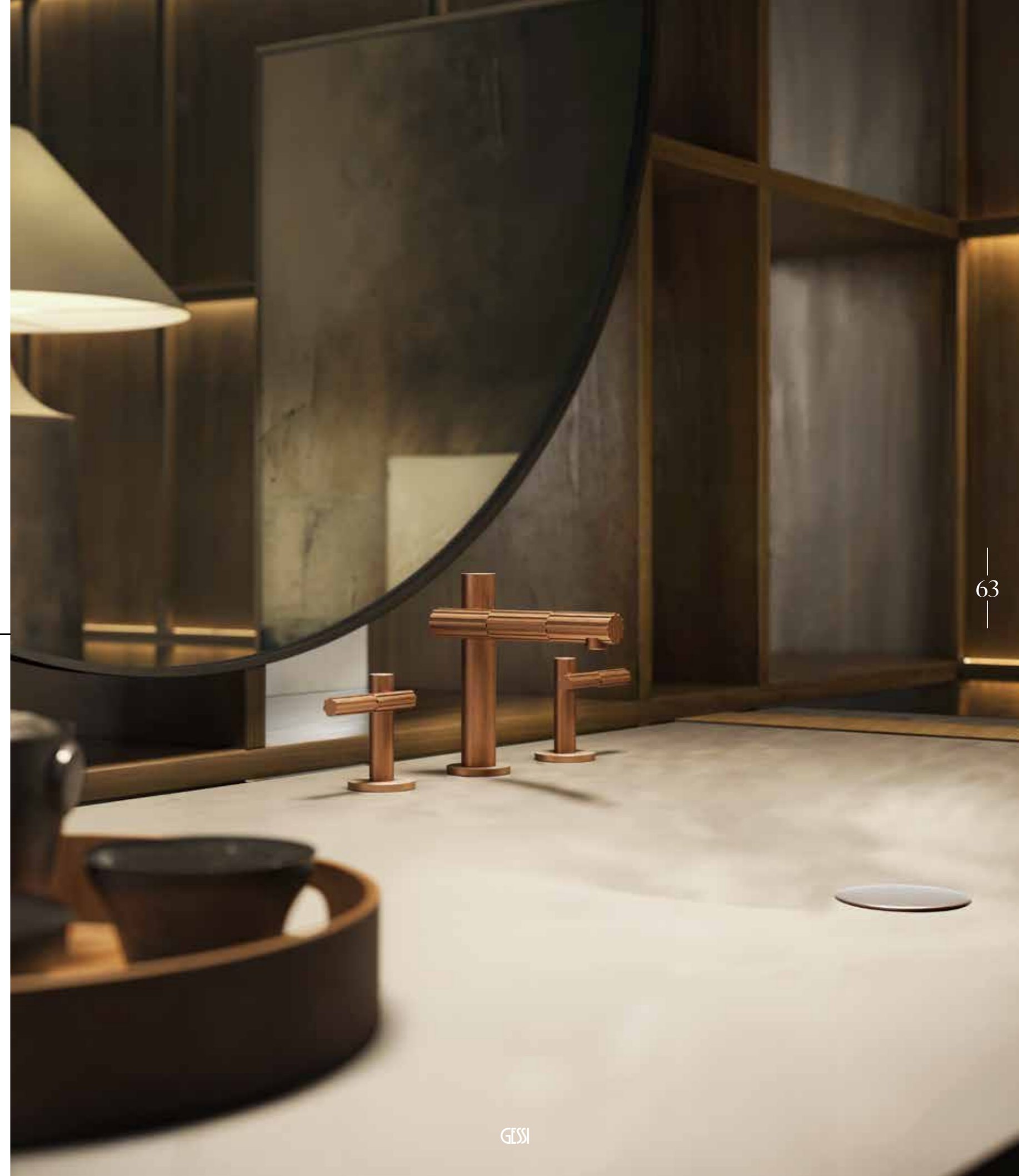

GESSI



INCASTRI



FORME IN  
 PERFETTA ARMONIA  
 FORMS IN  
 PERFECT  
 HARMONY

**75014#708** Three-hole basin mixer without waste /  
 Miscelatore lavabo tre fori senza scarico

**75413#030** Wall-mounted soap dispenser holder, ghiaccio /  
 Dispenser a muro, ghiaccio

**75407#030** Wall-mounted tumbler holder /  
 Porta bicchiere a muro

GESSI



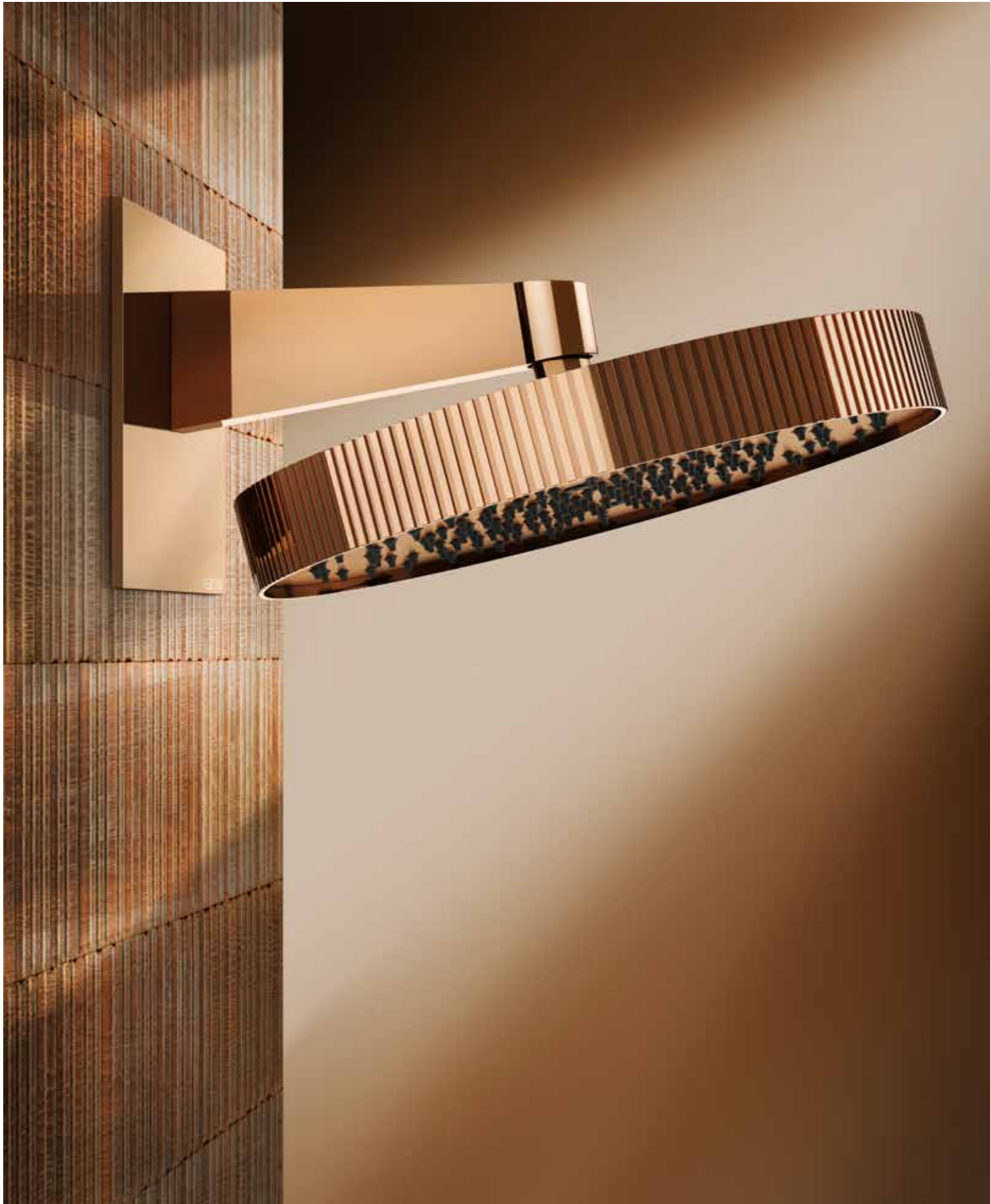

INCASTRI

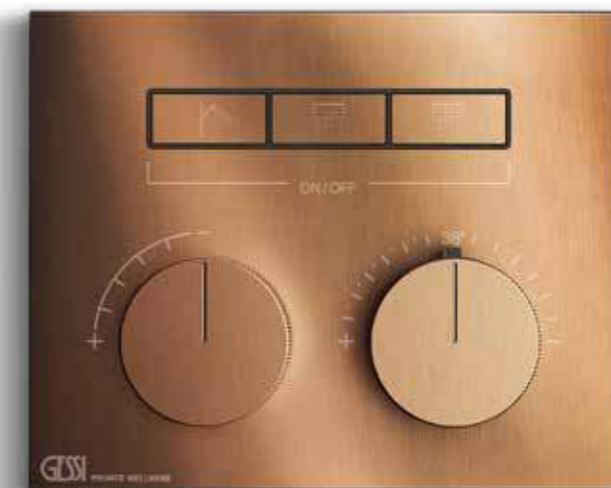

**75149#030** Wall-mounted adjustable showerhead / Soffione a parete orientabile.

**20295#030** Waterfall shower spout / Bocca doccia a parete a cascata

**63001\_63006#708** Thermostatic mixer for three separate functions, with push-button on/off controls / Miscelatore termostatico a tre funzioni indipendenti, con pulsanti on-off

A RESPECTFUL,  
DISCREET AND  
HUMAN MARK  
UN SEGNO RISPETTOSO,  
DISCRETO E UMANO

46189\_75028#708 Freestanding bath mixer /  
Miscelatore vasca da terra

INCASTRI

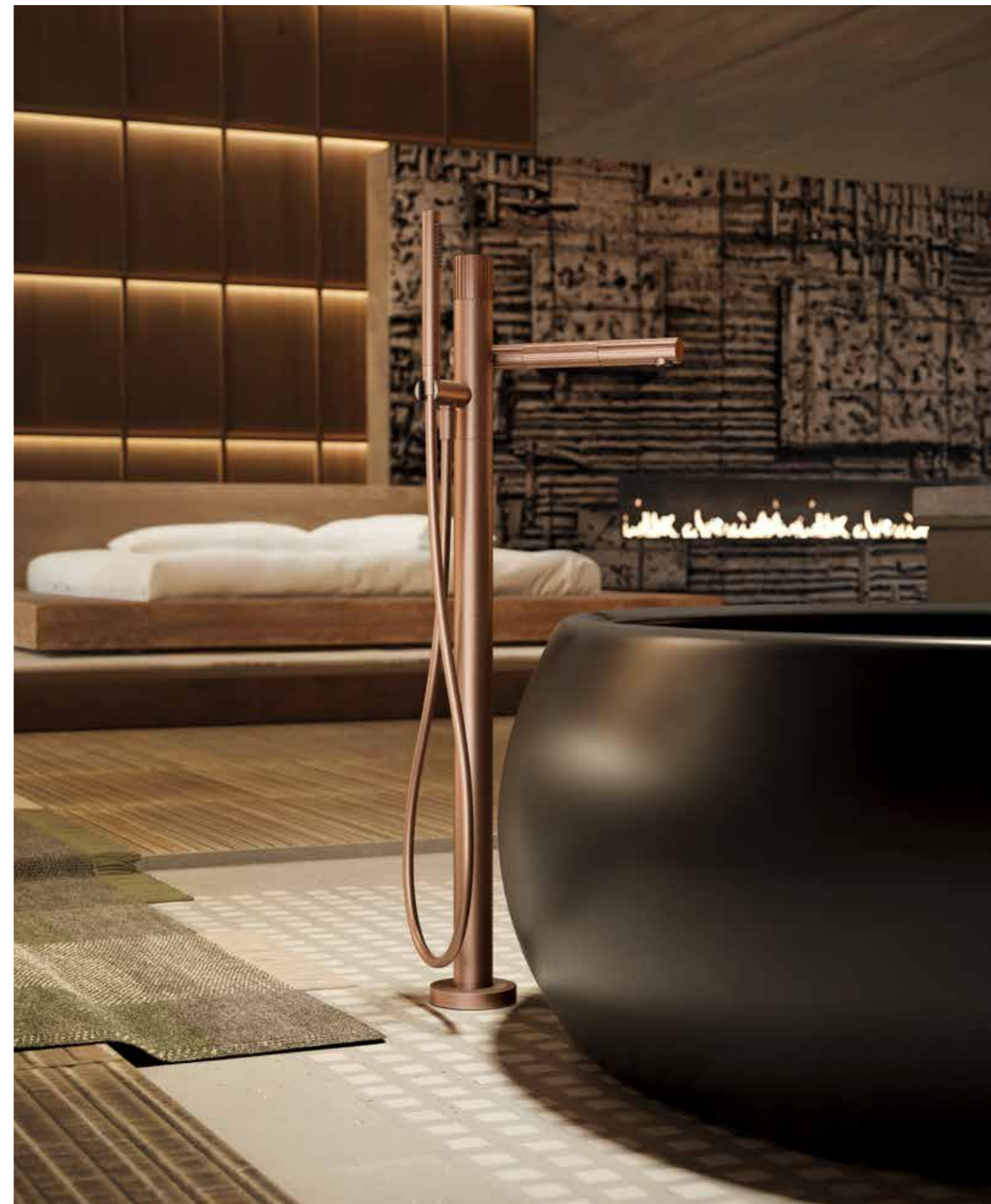

GESSI

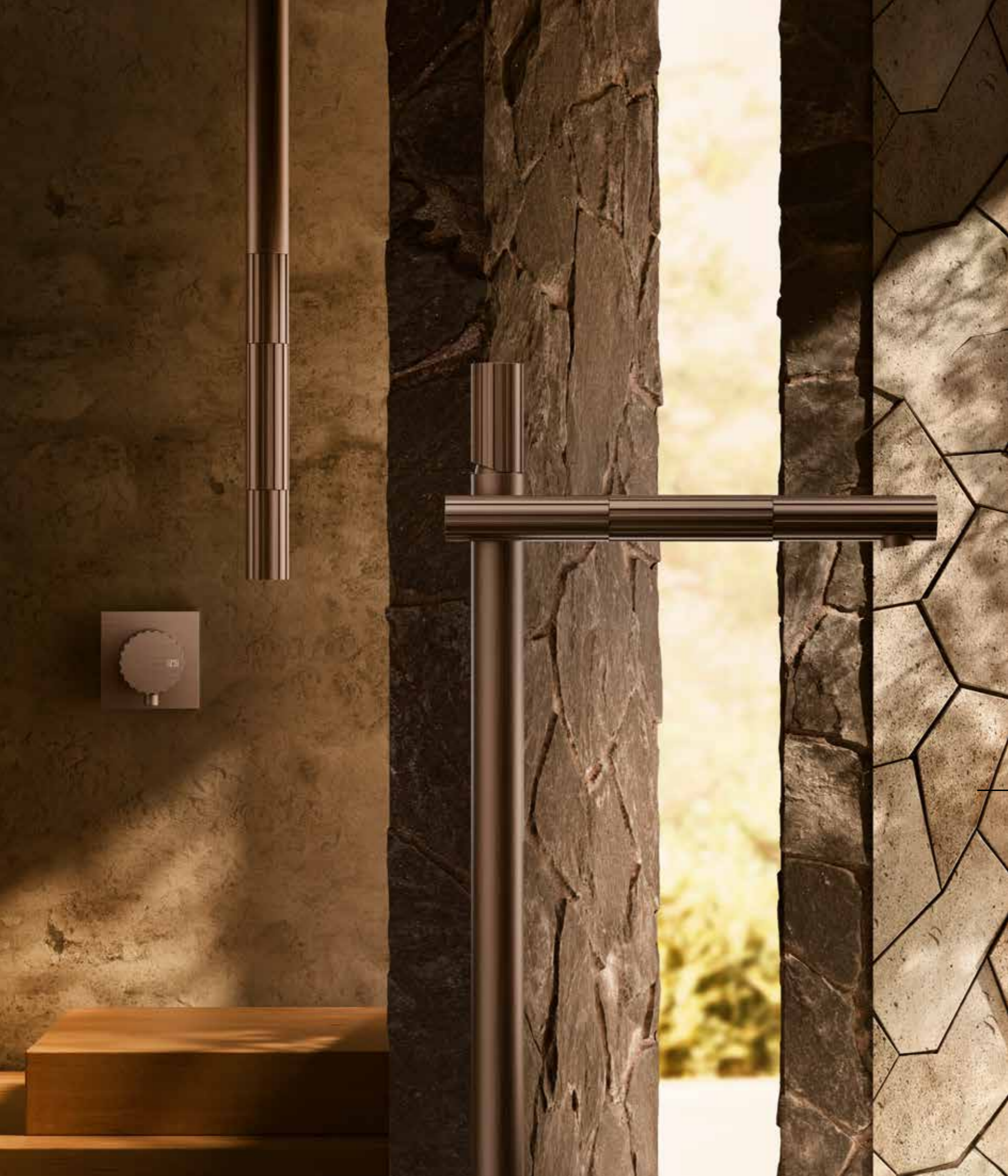

chapter

## 5

THE ARTISTIC VALUE  
OF DESIGN

## IL VALORE ARTISTICO DEL DESIGN

The aesthetic research behind Incastri bears the signature of Kengo Kuma. The involvement of one of the most renowned contemporary architects adds prestige, artistic value and exclusivity to the collection's design.

La ricerca estetica di Incastri porta la firma di Kengo Kuma. Il coinvolgimento di uno dei più celebri architetti contemporanei aggiunge prestigio, valore artistico ed esclusività al design della collezione.



74

75



INCASTRI



Le proposte da terra e da soffitto incarnano l'idea di un progetto che dialoga con lo spazio: ogni elemento è pensato per integrarsi nell'ambiente, dove ogni linea è necessaria e ogni forma porta con sé una storia da raccontare.

The floor and ceiling-mounted proposals embody the concept of a project in dialogue with space: each element is conceived to blend into its surroundings, where every line is essential and every form carries a story.

**PROFONDITÀ VISIVA E TATTILITÀ**

VISUAL DEPTH  
AND TACTILITY

46189\_75095#845 Freestanding basin mixer /  
Miscelatore lavabo da terra

GESSI

LA STORIA  
PRENDE FORMA

THE STORY  
TAKES SHAPE



The freestanding basin resembles a true sculpture, its volume reminiscent of a still block of water engaged in dialogue with the space. The object thus becomes an iconic element with a powerful visual and sensory presence, capable of delivering a tactile perception that is warm, profound and unexpected.

Il lavabo freestanding si presenta come una vera scultura, in cui il volume richiama un blocco d'acqua immobile che entra in dialogo con lo spazio. L'oggetto si trasforma così in un elemento iconico, dalla forte presenza visiva e sensoriale, capace di restituire una percezione tattile calda, profonda e inaspettata.

46189\_75095#299 Freestanding basin mixer /  
Miscelatore lavabo da terra

75607 Freestanding washbasin /  
Lavabo da terra

INCASTRI



GESSI



**75099#845** Ceiling-mounted spou. To be completed with separate control /  
Bocca a soffitto. Da completare con comando remoto

**75100#845** Separate control /  
Comando remoto da banco

**63412\_75109#845** Wall-mounted basin mixer one-way /  
Miscelatore lavabo a parete 1 via

INCASTRI



Il Chōzu, antico rituale giapponese di purificazione, insegna che anche il gesto quotidiano più semplice – sfiorare l'acqua, lavare le mani, rinfrescare il volto – può diventare consapevolezza, rispetto, intenzione.

Chōzu - the ancient Japanese ritual of purification - teaches us that even the simplest daily gestures - touching water, washing hands, refreshing the face - can become acts of awareness, respect and intention.

IL GESTO QUOTIDIANO  
COME RITO

THE DAILY  
GESTURE  
AS RITUAL

GESSI



INCASTRÌ

GESSÌ



84

### UN'OPERA DALLO STILE ICONICO

## A PIECE OF ICONIC STYLE

Pure forms, a simple composition and the interplay between solids, voids and tactile surfaces return a sense of intimacy and contemplation, where the body is renewed and time expands.

Le forme pure, la composizione essenziale e il rapporto tra pieni, vuoti e superfici tattili restituiscono una dimensione intima e contemplativa, in cui il corpo si rigenera e il tempo si distende.

**75168#845** Wall-mounted adjustable showerhead / Soffione a parete orientabile.

INCASTRI

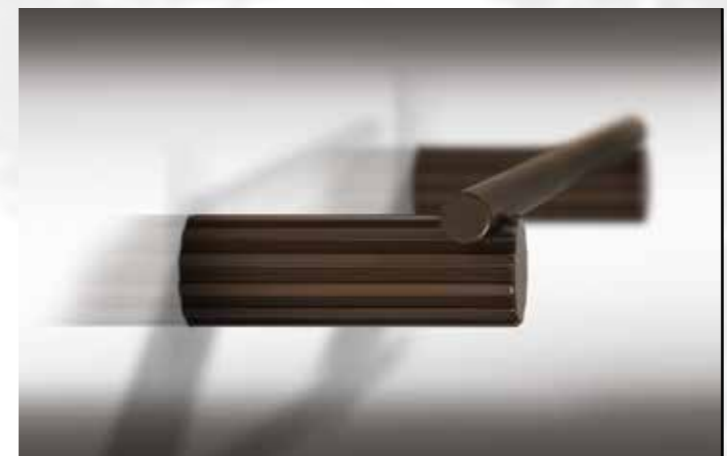

**75497#845** Porta salvietta a parete 30 cm / Wall-mounted towel holder 30 cm

**75040#845** Sliding rail with handshower, flexible hose and water outlet / Asta saliscendi con presa acqua, doccia e flessibile

GESI

85





75611#845 Cover plate /  
Placca di finitura



75068#845 Bidet mixer without waste /  
Miscelatore bidet senza scarico

Ogni elemento è pensato per integrarsi perfettamente all'ambiente circostante, arricchendo gli spazi con un linguaggio minimale, formale ed equilibrato.

**CONNESSIONE PROFONDA  
CON LO SPAZIO**  
A DEEP  
CONNECTION  
WITH THE SPACE

Every element is designed to integrate harmoniously with its environment, enriching spaces through a language that is minimal, formal and balanced.



75455#299 Wall-mounted paper roll holder /  
Porta rotolo a parete



75542#845 Door handles set /  
Set due maniglie per porta

Le maniglie sono elementi leggeri e poetici, che sembrano galleggiare nello spazio trasformando la materia in gesto architettonico. La tradizione giapponese viene così reinterpretata attraverso un design essenziale.

## UN TOCCO LEGGERO E POETICO

A LIGHT AND  
POETIC TOUCH

The handles are light, poetic elements that appear to float within the space, transforming matter into an architectural gesture. Japanese tradition is thus reinterpreted through essential design.

INCASTRI

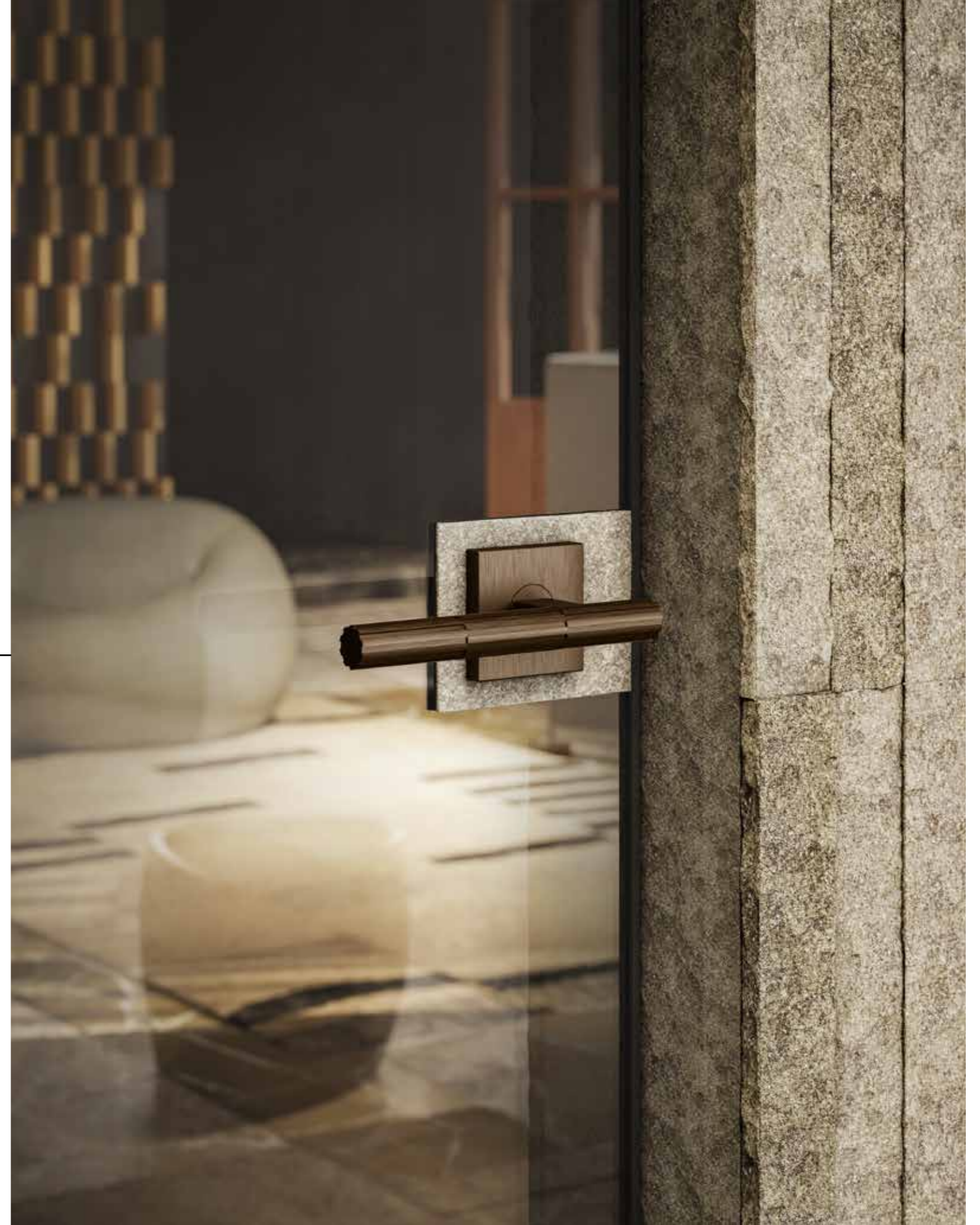

GESSI

PRODUCT LIST

## FINISHING LIST

- #031** Chrome
- #149** Finox Brushed Nickel
- #299** Matte Black
- #706** Black Metal PVD
- #707** Black Metal Brushed PVD
- #030** Copper PVD
- #708** Copper Brushed PVD
- #735** Warm Bronze PVD
- #726** Warm Bronze Brushed PVD
- #720** Nickel PVD
- #710** Brass PVD
- #727** Brass Brushed PVD
- #845** Dark Bronze
- #761** Coffee Bronze Brushed PVD
- #791** Deep Bronze Brushed PVD

# BASIN AREA



**75002**  
Basin mixer without waste /  
Miscelatore lavabo senza scarico  
**75051**  
With stop&go waste / Con scarico stop&go



**75004**  
High version basin mixer without waste /  
Miscelatore lavabo alto senza scarico  
**75053**  
With stop&go waste / Con scarico stop&go



**75204**  
High version basin mixer without waste. Sospeso /  
Miscelatore lavabo alto senza scarico. Sospeso  
**75253**  
With stop&go waste /  
Con scarico stop&go



**75202**  
Basin mixer without waste. Sospeso /  
Miscelatore lavabo senza scarico. Sospeso  
**75251**  
With stop&go waste. Sospeso /  
Con scarico stop&go. Sospeso



**75014**  
Three-hole basin mixer without waste /  
Miscelatore lavabo tre fori senza scarico



**09280\_75288**  
Wall-mounted basin mixer. Sospeso /  
Miscelatore lavabo a parete. Sospeso



**63397\_75088**  
Wall-mounted basin mixer /  
Miscelatore lavabo a parete

# BASIN AREA



**46189\_75095**  
Freestanding basin mixer /  
Miscelatore lavabo da terra



**75099**  
Ceiling-mounted spout. To be completed with  
separate control / Bocca a soffitto.  
Da completare con comando remoto  
**75199**  
Lenght on request / Altezza personalizzabile



**75100**  
Separate control /  
Comando remoto da banco



**63412\_75109**  
Wall-mounted basin mixer one-way /  
Miscelatore lavabo a parete 1 via



**75102**  
Wall-mounted basin spout /  
Bocca lavabo a parete



**75601**  
Counter washbasin 40x40 cm /  
Lavabo da appoggio 40x40 cm



**75603**  
Counter washbasin 65x40 cm /  
Lavabo da appoggio 65x40 cm



**75607**  
Freestanding washbasin /  
Lavabo da terra  
**75609** with light / con luce



**01410**  
1 1/4" Syphon /  
Sifone da 1 1/4"



**01377**  
1 1/4" Syphon /  
Sifone da 1 1/4"



**01412**  
Underbasin mixer with filter  
and 1/2" connection / Rubinetto  
sottolavabo con filtro e attacco da 1/2"



**01411**  
Underbasin mixer with filter  
and 1/2" connection / Rubinetto  
sottolavabo con filtro e attacco da 1/2"

# BASIN AREA



**75401**  
Wall-mounted soap holder /  
Porta sapone a parete



**75407**  
Wall-mounted tumbler holder /  
Porta bicchiere a parete



**75413**  
Wall-mounted soap dispenser holder /  
Dispenser a parete



**75521**  
Wall-mounted robe hook /  
Appendino a parete



**75500**  
45 cm centre distance towel rail /  
Porta salvietta a parete 45 cm  
**75497** 30 cm  
**75503** 60 cm

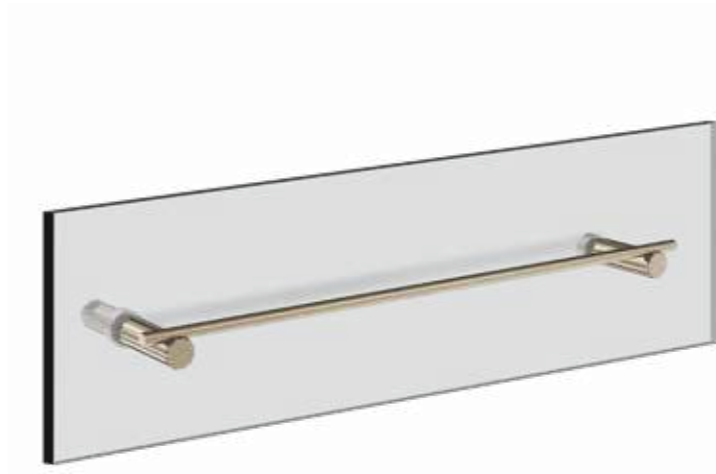

**75513**  
45 cm centre distance towel rail or glass  
fixing / Porta salvietta a parete per vetro  
45 cm  
**75511** 30 cm  
**75515** 60 cm



**20988**  
Adjustable standing mirror /  
Specchio d'appoggio orientabile



**20991**  
Black waste-paper basket / Gettacarta nero  
**20990**  
White / Bianco



**75425**  
Standing soap holder /  
Porta sapone da appoggio



**75431**  
Standing tumbler holder /  
Porta bicchiere da appoggio



**75437**  
Standing soap dispenser holder /  
Dispenser da appoggio

# BATH & SHOWER AREA



**46189\_75028**  
Freestanding bath mixer /  
Miscelatore vasca da terra



**75103**  
Wall-mounted bath spout /  
Bocca vasca a parete



**75521**  
Wall-mounted robe hook /  
Appendino a parete



**20861**  
Bath or shower shelf /  
Mensola per vasca o doccia



**54139\_75036**  
Wall-mounted two-ways shower mixer with  
handshower / Miscelatore doccia a parete,  
due vie con doccia



**75500**  
45 cm centre distance towel rail /  
Porta salvietta a parete 45 cm  
**75497** 30 cm  
**75503** 60 cm



**20947**  
Shelf 30 cm / Mensola 30 cm  
**20949** 60 cm  
**20950** 60x24 cm  
**20945** 60 cm with verex /  
60 cm con verex



**58424**  
Grab-bar / Maniglione d'appoggio

# BATH & SHOWER AREA



**54073\_75038**  
Wall-mounted shower mixer, 2 ways /  
Miscelatore doccia a parete 2 vie  
**54055\_75061** 1 way / 1 uscita

**54169\_75132**  
Thermostatic mixer with 1 way /  
Miscelatore termostatico 1 uscita  
**54169\_75134** 2 ways / 2 uscite  
**54169\_75136** 3 ways / 3 uscite



**09269\_75135**  
Thermostatic 2 ways mixer /  
Miscelatore termostatico 2 vie  
**09269\_75133** 1 way / 1 via  
**09269\_75137** 3 ways / 3 vie



**43105\_75316**  
Thermostatic high-capacity mixer with 3  
separate exits / Miscelatore termostatico  
alta portata 3 uscite indipendenti  
**43103\_75314** 2 exits / 2 uscite  
**43107\_75318** 4 exits / 4 uscite  
**43109\_75320** 5 exits / 5 uscite

**43105\_75306**  
Thermostatic high-capacity mixer with 3  
separate exits / Miscelatore termostatico  
alta portata 3 uscite indipendenti  
**43103\_75304** 2 exits / 2 uscite  
**43107\_75308** 4 exits / 4 uscite  
**43109\_75310** 5 exits / 5 uscite



**09266\_75336**  
Wall-mounted thermostatic mixer with 3  
separate exits / Miscelatore termostatico a  
parete 3 uscite indipendenti  
**09264\_75334** 2 exits / 2 uscite  
**09268\_75338** 4 exits / 4 uscite  
**09263\_75330** 5 exits / 5 uscite



**75149**  
Wall-mounted adjustable showerhead. INCASTRI /  
Soffione a parete orientabile. INCASTRI  
**63049**



**75168**  
Wall-mounted adjustable showerhead. INCASTRI /  
Soffione a parete orientabile. INCASTRI  
**63068**



**75172**  
Ceiling-mounted adjustable showerhead. INCASTRI /  
Soffione a soffitto orientabile. INCASTRI  
**63072**  
**75170** Custom length / Lunghezza personalizzata  
**63070**



**75148**  
Wall-mounted shower head /  
Soffione a parete



**75040**  
Sliding rail with handshower, flexible hose  
and water outlet / Asta saliscendi con  
presa acqua, doccetta e flessibile  
**75042** Without water outlet /  
Senza presa acqua  
**75044** Sliding rail / Asta saliscendi

**73523**  
Shower set / Set doccia

# SHOWER AREA



**63011\_63012**  
Thermostatic mixer for 2 separate functions,  
with push-button on/off controls /  
Miscelatore termostatico a 2 funzioni  
indipendenti, con pulsanti on-off

**63013\_63014** 3 functions / 3 funzioni  
**63015\_63016** 4 functions / 4 funzioni  
**63017\_63018** 5 functions / 5 funzioni

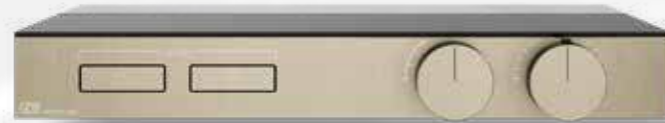

**63021\_63022**  
Thermostatic shelf mixer for 2 separate functions,  
with push-button on/off controls /  
Miscelatore termostatico a mensola a 2 funzioni  
indipendenti, con pulsanti on-off

**63023\_63024** 3 functions / 3 funzioni  
**63025\_63026** 4 functions / 4 funzioni  
**63027\_63028** 5 functions / 5 funzioni



**63001\_63004**  
Thermostatic mixer for 2 separate functions,  
with push-button on/off controls /  
Miscelatore termostatico a 2 funzioni  
indipendenti, con pulsanti on-off

**63001\_63006** 3 functions / 3 funzioni



**63055\_63079**  
Single-lever mixer for 2 separate  
functions, with push-button on/  
off controls / Miscelatore  
monocomando a 2 funzioni  
indipendenti, con pulsanti on-off.

**63055\_63081** 3 functions /  
3 funzioni

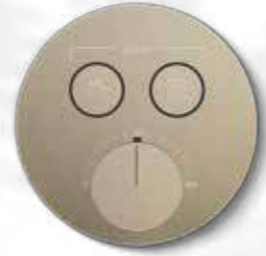

**38267\_38713**  
Thermostatic mixer for 2 separate functions,  
with push-button on/off controls /  
Miscelatore termostatico a 2  
funzioni indipendenti, con pulsanti on/off

**38266\_38711** 1 function / 1 funzione  
**38268\_38716** 3 functions / 3 funzioni



**38267\_38718**  
Thermostatic mixer for 2 separate functions, with  
push-button on/off controls /  
Miscelatore termostatico a 2  
funzioni indipendenti, con pulsanti on/off

**38266\_38717** 1 function / 2 funzione  
**38268\_38719** 3 functions / 3 funzioni



**63099**  
Magnetic Shower set /  
Set doccia con supporto magnetico  
**63199**



**57307\_57004**  
300 x 300 rainfall / waterfall  
**57303\_57002** 300 x 300 rainfall  
**57305\_57004** 300 x 300 rainfall / waterfall built-in  
**57301\_57002** 300 x 300 rainfall built-in  
**57411\_57010** 300 x 500 rainfall / waterfall / mist  
**57403\_57006** 300 x 500 rainfall  
**57409\_57010** 300 x 500 rainfall / waterfall / mist built-in  
**57401\_57006** 300 x 500 rainfall built-in  
**57511\_57016** 500 x 500 rainfall / waterfall / mist  
**57503\_57012** 500 x 500 rainfall  
**57509\_57016** 500 x 500 rainfall / waterfall / mist built-in  
**57501\_57012** 500 x 500 rainfall built-in  
**57603\_57018** Ø350 rainfall  
**57601\_57018** Ø350 rainfall built-in



**57961\_57963**  
Multifunction system with chromotherapy.  
rainfall / waterfall / Mist functions /  
Sistema multifunzione con effetto  
cromoterapia. Funzioni pioggia / cascata /  
nebulizzata



**20295**  
Waterfall shower spout /  
Bocca doccia a parete a cascata



**32978\_32984**  
Built-in adjustable lateral body jet /  
Soffione laterale orientabile ad incasso



**32975**  
Lateral body jet /  
Soffione laterale

**57801\_57871**  
350 x 350 rainfall  
**57807\_57875** 350 x 350 multifunction  
**57805\_57006** 300 x 500 rainfall  
**57811\_57010** 300 x 500 multifunction  
**57901\_57012** 500 x 500 rainfall  
**57907\_57016** 500 x 500 multifunction  
**57803\_57018** Ø350 rainfall  
**57809\_57873** Ø350 multifunction  
**57903\_57973** Ø500 rainfall  
**57909\_57975** Ø500 multifunction



**57827\_57876**  
350 x 350 multifunction  
**57831\_57882** 300 x 500 multifunction  
**57927\_57977** 500 x 500 multifunction  
**57829\_57878** Ø350 multifunction  
**57929\_57980** Ø500 multifunction



**32973**  
Lateral body jet /  
Soffione laterale



**32979**  
Wall-mounted atomizer  
jet / Soffione laterale  
a getto nebulizzato



**20172**  
Adjustable lateral  
body jet / Soffione  
laterale orientabile

# SHOWER AREA



**63215\_63207**  
Two ways shower column /  
Colonna doccia 2 vie

**63214**  
Lever kit with handshower /  
Kit maniglia con doccia

**57271**  
Wall-mounted adjustable showerhead,  
three settings function - see OUTDOOR/  
Soffione a parete orientabile, funzione  
tre getti - vedi OUTDOOR



**57261**  
Wall-mounted adjustable showerhead, multi-spray  
function / Soffione a parete orientabile, funzione  
multi-spray

**57263** Rain / Poggia  
**57265** Atomizer / Nebulizzazione  
**57267** Waterfall / Cascata  
**57269** Three settings / Tre getti



**75521**  
Wall-mounted robe hook /  
Appendino a parete



**20861**  
Bath or shower shelf /  
Mensola per vasca o doccia



**75500**  
45 cm centre distance towel rail /  
Porta salvietta a parete 45 cm

**75497** 30 cm  
**75503** 60 cm



**20947**  
Shelf 30 cm / Mensola 30 cm  
**20949** 60 cm  
**20950** 60X24 cm  
**20945** 60 cm with verex /  
60 cm con verex

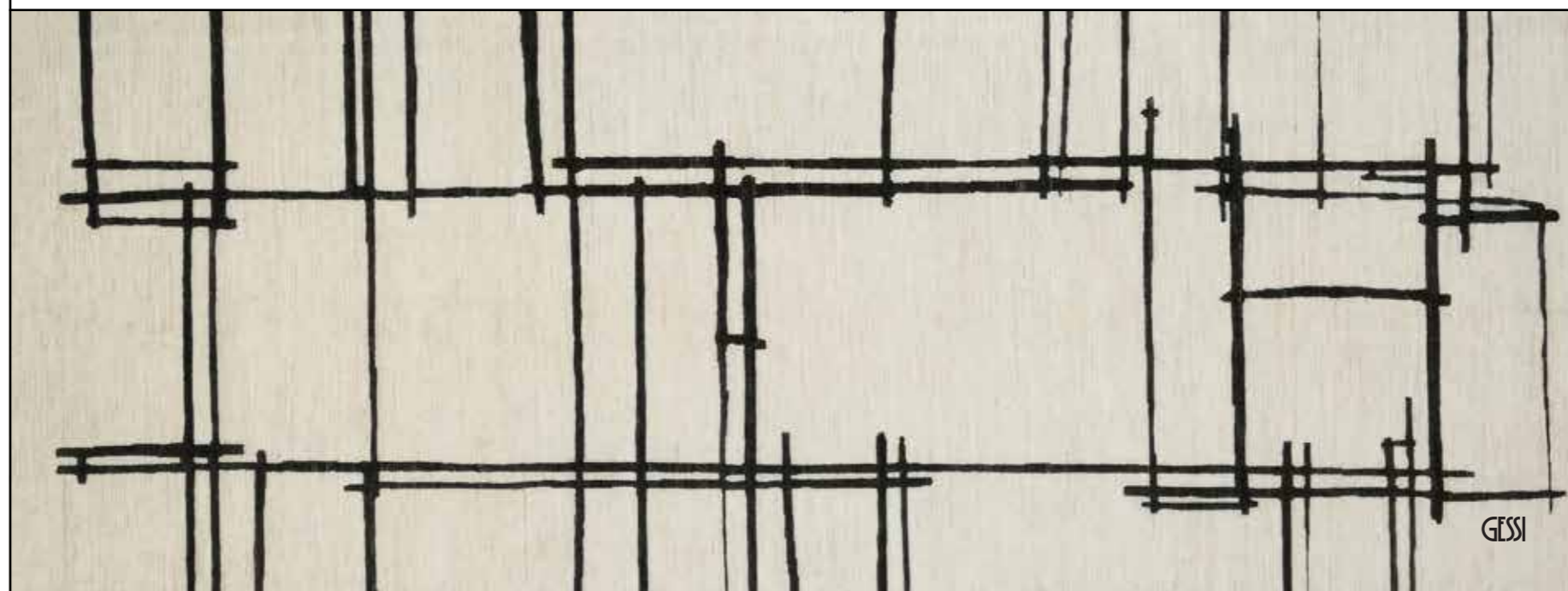

GESSI



**58424**  
Grab-bar / Maniglione d'appoggio

# SHOWER AREA



**67503** RIGATO  
**67603** DIAMANTATO  
**67003** UNITO  
 Wall-Glass click-on hinge 8-10 mm /  
 Cerniera a scatto muro-vetro 8-10 mm  
**67517** RIGATO  
**67617** DIAMANTATO  
**67017** UNITO  
 Left opening lifting function /  
 Con alzata in apertura a sinistra  
**67515** RIGATO  
**67615** DIAMANTATO  
**67015** UNITO  
 Right opening lifting function /  
 Con alzata in apertura a destra  
**67504** RIGATO  
**67604** DIAMANTATO  
**67004** UNITO  
 12 mm / 12 mm  
**67518** RIGATO  
**67618** DIAMANTATO  
**67018** UNITO  
 12 mm. Left opening lifting function /  
 12 mm. Con alzata in apertura a sinistra  
**67516** RIGATO  
**67616** DIAMANTATO  
**67016** UNITO  
 12 mm. Right opening lifting function /  
 12 mm. Con alzata in apertura a destra



**RIGATO**  
**67505**  
 Wall-glass clamp. 8-10-12 mm glass thickness /  
 Morsetto muro-vetro. Spessore vetro 8-10-12 mm  
**DIAMANTATO**  
**67605**  
**UNITO**  
**67005**



**RIGATO**  
**67506**  
 Wall-glass clamp. 8-10-12 mm glass thickness /  
 Morsetto muro-vetro. Spessore vetro 8-10-12 mm  
**DIAMANTATO**  
**67606**  
**UNITO**  
**67006**



**RIGATO**  
**67507**  
 Glass-glass clamp 90°. 8-10-12 mm glass thickness /  
 Morsetto vetro-vetro 90°. Spessore vetro 8-10-12 mm  
**DIAMANTATO**  
**67607**  
**UNITO**  
**67007**



**67501** RIGATO  
**67601** DIAMANTATO  
**67001** UNITO  
 Wall-Glass click-on hinge 8-10 mm /  
 Cerniera a scatto muro-vetro 8-10 mm  
**67513** RIGATO  
**67613** DIAMANTATO  
**67013** UNITO  
 Left opening lifting function /  
 Con alzata in apertura a sinistra  
**67511** RIGATO  
**67611** DIAMANTATO  
**67011** UNITO  
 Right opening lifting function /  
 Con alzata in apertura a destra  
**67502** RIGATO  
**67602** DIAMANTATO  
**67002** UNITO  
 12 mm / 12 mm  
**67514** RIGATO  
**67614** DIAMANTATO  
**67014** UNITO  
 12 mm. Left opening lifting function /  
 12 mm. Con alzata in apertura a sinistra  
**67512** RIGATO  
**67612** DIAMANTATO  
**67012** UNITO  
 12 mm. Right opening lifting function /  
 12 mm. Con alzata in apertura a destra



**67581** RIGATO  
**67681** DIAMANTATO  
**67081** UNITO  
 Wall-Glass click-on hinge 8-10 mm /  
 Cerniera a scatto muro-vetro 8-10 mm  
**67587** RIGATO  
**67687** DIAMANTATO  
**67087** UNITO  
 Left opening lifting function /  
 Con alzata in apertura a sinistra  
**67585** RIGATO  
**67685** DIAMANTATO  
**67085** UNITO  
 Right opening lifting function /  
 Con alzata in apertura a destra  
**67582** RIGATO  
**67682** DIAMANTATO  
**67082** UNITO  
 12 mm / 12 mm  
**67588** RIGATO  
**67688** DIAMANTATO  
**67088** UNITO  
 12 mm. Left opening lifting function /  
 12 mm. Con alzata in apertura a sinistra  
**67586** RIGATO  
**67686** DIAMANTATO  
**67086** UNITO  
 12 mm. Right opening lifting function /  
 12 mm. Con alzata in apertura a destra



**67519** RIGATO  
**67619** DIAMANTATO  
**67019** UNITO  
 Wall-Glass click-on hinge 8-10 mm /  
 Cerniera a scatto muro-vetro 8-10 mm  
**67595** RIGATO  
**67695** DIAMANTATO  
**67095** UNITO  
 Left opening lifting function /  
 Con alzata in apertura a sinistra  
**67593** RIGATO  
**67693** DIAMANTATO  
**67093** UNITO  
 Right opening lifting function /  
 Con alzata in apertura a destra  
**67520** RIGATO  
**67620** DIAMANTATO  
**67020** UNITO  
 12 mm / 12 mm  
**67596** RIGATO  
**67696** DIAMANTATO  
**67096** UNITO  
 12 mm. Left opening lifting function /  
 12 mm. Con alzata in apertura a sinistra  
**67594** RIGATO  
**67694** DIAMANTATO  
**67094** UNITO  
 12 mm. Right opening lifting function /  
 12 mm. Con alzata in apertura a destra



**67583** RIGATO  
**67683** DIAMANTATO  
**67083** UNITO  
 Wall-Glass click-on hinge 8-10 mm /  
 Cerniera a scatto muro-vetro 8-10 mm  
**67591** RIGATO  
**67691** DIAMANTATO  
**67091** UNITO  
 Left opening lifting function /  
 Con alzata in apertura a sinistra  
**67589** RIGATO  
**67689** DIAMANTATO  
**67089** UNITO  
 Right opening lifting function /  
 Con alzata in apertura a destra  
**67584** RIGATO  
**67684** DIAMANTATO  
**67084** UNITO  
 12 mm / 12 mm  
**67592** RIGATO  
**67692** DIAMANTATO  
**67092** UNITO  
 12 mm. Left opening lifting function /  
 12 mm. Con alzata in apertura a sinistra  
**67590** RIGATO  
**67690** DIAMANTATO  
**67090** UNITO  
 12 mm. Right opening lifting function /  
 12 mm. Con alzata in apertura a destra



**RIGATO**  
**67599**  
 Glass-glass clamp 90°. 8-10-12 mm glass thickness /  
 Morsetto vetro-vetro 90°. Spessore vetro 8-10-12 mm  
**DIAMANTATO**  
**67699**  
**UNITO**  
**67099**



**RIGATO**  
**67508**  
 Glass-glass clamp 180°. 8-10-12 mm glass thickness /  
 Morsetto vetro-vetro 180°. Spessore vetro 8-10-12 mm  
**DIAMANTATO**  
**67608**  
**UNITO**  
**67008**

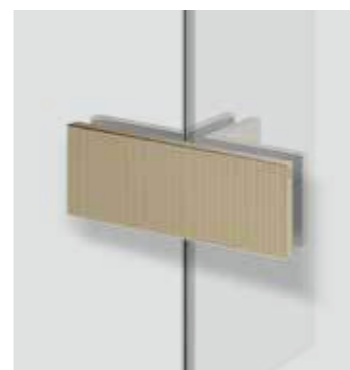

**RIGATO**  
**67509**  
 T-shape Glass-glass clamp. 8-10-12 mm glass thickness /  
 Morsetto vetro-vetro a T. Spessore vetro 8-10-12 mm  
**DIAMANTATO**  
**67609**  
**UNITO**  
**67009**



**RIGATO**  
**67510**  
 Glass holding adjustable arm. 8-10 mm glass thickness /  
 Braccio ferma vetro regolabile. Spessore vetro 8-10 mm  
**DIAMANTATO**  
**67610**  
**UNITO**  
**67010**

# SHOWER AREA



**RIGATO**  
**67571**  
Glass holding arm 8-10 mm /  
Braccio ferma vetro 8-10 mm  
**67572** 12 mm  
**DIAMANTATO**  
**67671** 8-10 mm  
**67672** 12 mm  
**UNITO**  
**67071** 8-10 mm  
**67072** 12 mm



**RIGATO**  
**67575**  
T-shaped glass holding  
adjustable arm 8-10 mm /  
Braccio ferma vetro a T  
regolabile 8-10 mm.  
**67576** 12 mm  
**DIAMANTATO**  
**67675** 8-10 mm  
**67674** 12 mm  
**UNITO**  
**67075** 8-10 mm  
**67076** 12 mm

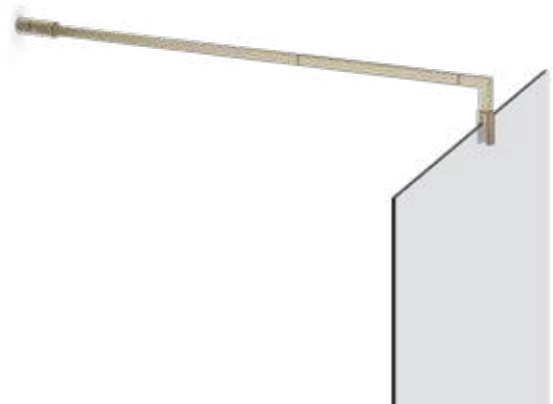

**RIGATO**  
**67573**  
Glass holding adjustable arm 8-10 mm /  
Braccio ferma vetro regolabile 8-10 mm  
**67574** 12 mm  
**DIAMANTATO**  
**67673** 8-10 mm  
**67674** 12 mm  
**UNITO**  
**67073** 8-10 mm  
**67074** 12 mm



**RIGATO**  
**67577**  
Ceiling-mounted glass holding  
adjustable arm 8-10 mm /  
Braccio ferma vetro a soffitto 8-10 mm  
**67578** 12 mm  
**DIAMANTATO**  
**67677** 8-10 mm  
**67678** 12 mm  
**UNITO**  
**67077** 8-10 mm  
**67078** 12 mm



**RIGATO**  
**67523**  
30 cm Handle for glass fixing /  
Maniglia per vetro 30 cm  
**67521** RIGATO 20 cm  
**67525** RIGATO 45 cm  
**67527** RIGATO 60 cm  
**DIAMANTATO**  
**67623** 30 cm  
**67621** 20 cm  
**67625** 45 cm  
**67627** 60 cm  
**UNITO**  
**67023** 30 cm  
**67021** 20 cm  
**67025** 45 cm  
**67027** 60 cm



**RIGATO**  
**67542**  
30 cm Handle and towel rail for glass fixing /  
Maniglia e porta salvietta per vetro 30 cm  
**67544** 45 cm  
**67546** 60 cm  
**DIAMANTATO**  
**67642** 30 cm  
**67644** 45 cm  
**67646** 60 cm  
**UNITO**  
**67042** 30 cm  
**67044** 45 cm  
**67046** 60 cm



**RIGATO**  
**67533**  
30 cm Double handle for glass fixing /  
Maniglia doppia per vetro 30 cm  
**67531** 20 cm  
**67535** 45 cm  
**67537** 60 cm  
**DIAMANTATO**  
**67633** 30 cm  
**67631** 20 cm  
**67635** 45 cm  
**67637** 60 cm  
**UNITO**  
**67033** 30 cm  
**67031** 20 cm  
**67035** 45 cm  
**67037** 60 cm

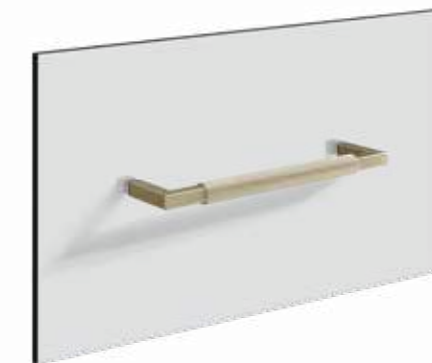

**RIGATO**  
**67541**  
30 cm Handle and towel rail for glass  
fixing / Porta salvietta per vetro 30 cm  
**67543** 45 cm  
**67545** 60 cm  
**DIAMANTATO**  
**67641** 30 cm  
**67643** 45 cm  
**67645** 60 cm  
**UNITO**  
**67041** 30 cm  
**67043** 45 cm  
**67045** 60 cm



**67050\_67053**  
Linear drain with lateral cover 70 cm /  
Scarico lineare con cover laterali 70 cm  
**67050\_67051** 60 cm  
**67050\_67055** 80 cm  
**67050\_67057** 90 cm

**RIGATO**  
**67561**  
Central cover / Cover centrale  
**DIAMANTATO**  
**67661**  
**UNITO**  
**67061**

# SANITARY AREA



**39113**  
Wall hung WC (6 litres) in Ceramic, integrate siphon. Soft-closing hardware / Vaso in Ceramica a parete (6litri) con sifone integrato. Cerniere Soft-close incluse

#518 white ceramic  
#531 matte white ceramic  
#532 matte black ceramic



**39118**  
Wall hung WC (6 litres) in Ceramic, integrate siphon. Soft-closing hardware / Vaso in Ceramica a parete (6litri) con sifone integrato. Cerniere Soft-close incluse

#518 white ceramic  
#531 matte white ceramic  
#532 matte black ceramic



**76511**  
Cover plate GEBERIT SIGMA 8 and 12 / Placca di finitura per GEBERIT SIGMA 8 e 12

76513 VIEGA 1H, 2H, 2L  
76515 GEBERIT OMEGA 12  
76517 TECE  
76519 SANIT  
76521 VIEGA PREVISTA 12



**75455**  
Wall-mounted paper roll / Porta rotolo



**75421**  
Wall-mounted brush holder / Porta scopino a muro  
**75445** Standing / da appoggio



**45122**  
Hydrobrush for sanitary ceramics with safety valve / Scopino a getto d'acqua per ceramica sanitaria con valvola di sicurezza



**09276\_45131**  
Shut-off douchette with mixer / Doccetta shut-off con miscelatore  
**09276\_45130**

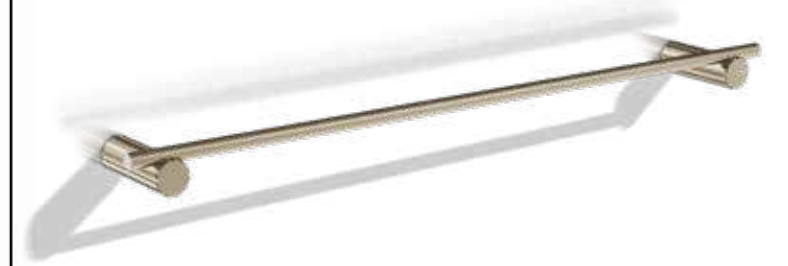

**75500**  
45 cm centre distance towel rail / Porta salvietta a parete 45 cm



**39115**  
Wall hung Bidet in Ceramic, with overflow waste and hole for tap and fittings / Bidet in Ceramica a parete con troppopieno e foro centrale per rubinetteria

#518 white ceramic  
#531 matte white ceramic  
#532 matte black ceramic



**75067**  
Bidet mixer with stop&go waste / Miscelatore bidet con scarico stop&go

**75068**  
Without waste / Senza scarico



**01375**  
Syphon Bidet / Sifone Bidet



# MANIGLIE HANDLES AREA



**75542**  
Door handles set /  
Set due maniglie per porta



**75540**  
Patent door handles set /  
Set due maniglie per porta. Patent



**75541**  
Yale door handles set /  
Set due maniglie per porta. Yale



**75543**  
Door lock / Chiavistello



**75631**  
Double handle for glass/wood 30 cm /  
Maniglia doppia per vetro/legno 30 cm  
**75630** 20 cm  
**75632** 45 cm  
**75633** 60 cm



**75546**  
Door handles set /  
Set due maniglie per porta



**75544**  
Patent door handles set /  
Set due maniglie per porta. Patent



**75545**  
Yale door handles set /  
Set due maniglie per porta. Yale



**75635**  
Bar handle 30 cm /  
Maniglione a barra 30 cm  
**75634** 20 cm  
**75636** 45 cm  
**75637** 60 cm

INCASTRI

GESSI

ED. NOVEMBER 2025

**GMC008780**

The images and descriptions included in our literature do not constitute an obligation of an accurate realization of the product, the details and the measurement included are to be used as a guide and maybe modified without notice. Possible mistakes and/or misprints of current catalogue will not be object of dispute.

Le illustrazioni e le descrizioni contenute nel presente catalogo e negli stampati della venditrice non comportano obbligo di fedele esecuzione; i dettagli e le misure contenute sono da considerarsi indicativi e soggetti a modifiche senza preavviso. Eventuali errori e/o refusi di stampa del presente catalogo non costituiscono motivo di contestazione.

GESSE SpA 捷仕  
Parco Gessi - 13037 Serravalle Sesia  
(Vercelli) ITALY  
Tel. +39 0163 454111  
Fax +39 0163 459273  
gessi@gessi.it  
**gessi.com**

